



# MixRite E-300 SOLAR-User Guide

79000000042

07.2022



SCAN FOR TEFEN APP



## Table of Contents

Introduction - Safety guidelines.....	3
P1 - Technical data.....	4
P2 - Assembly instructions and installation.....	5
P3 - Set pump parameter and operation.....	6-7
P4 - Troubleshooting.....	8
P5 - Maintenance.....	9
P6 - Additive flow and motor % with pressure.....	10
P7 - Kits list.....	11-12
P8 - Pump spare parts.....	13

## Introduction









TEFEN's E300 fertilizer pump designed to ensure injecting precise amount of fertilizer to your irrigation system.

E-300 electric dosing pump injects liquid additives directly to your water lines.

The E300 can operate as an accessory of irrigation controller with AC or DC Latch control outputs.

## GENERAL SAFETY GUIDELINES

Carefully follow the installation instruction

	Keep the pump protected from sun and water. Avoid water splashes.
	All hazardous electric voltage jobs must be conducted by a local qualified electrician and according to local regulations.
	Do not leave the electrical compartment, hood, or any connection box open while the machine is running or while you are away.
	When installing always observe national regulations. electrical installation must comply with the local safety standards and regulations
	Before any operation: always read chemical Material Safety Data Sheet (MSDS) always discharge the liquid end before servicing the pump. empty and rinse the liquid end before work on a pump that has been used with hazardous or unknown chemicals.
	Always use protective equipment, gloves, and goggles when handling fertilizers, acid and other chemicals!
	Do not use in explosive area (EX). Do not use with flammable chemicals. Do not use with radioactive chemicals.
	This equipment requires regular maintenance to ensure potability requirements of the water and maintenance of improvements as declared by the manufacturer.

## P1. Technical Data

Category	Details
<b>Internal Pump's motor info</b>	<ul style="list-style-type: none"> <li>• Operation Voltage – 12 DC</li> <li>• Maximum Current – 8 A</li> <li>• Power Consumption – 96 W</li> </ul>
<b>Power Supply</b>	<ul style="list-style-type: none"> <li>• 12V DC, 8A</li> </ul>
<b>Hydraulic Connection</b>	<ul style="list-style-type: none"> <li>• 3/4"NPT Female</li> </ul>
<b>Additive Temperature</b>	<ul style="list-style-type: none"> <li>• Max 77 C° (170 F°)</li> </ul>
<b>Priming</b>	<ul style="list-style-type: none"> <li>• Self-Priming Up To 1.5m (5 Ft.) Vertical, Max. Inlet Pressure 2.1 Bar (30 PSI)</li> </ul>
<b>Max. Flow Rate L/h</b>	<ul style="list-style-type: none"> <li>• Max – 314 L/H (1.38GPM) at 1 bar (14.5 psi)</li> </ul>
<b>Pressure</b>	<ul style="list-style-type: none"> <li>• Max – 5.0 bar (72 psi)</li> </ul>
<b>Ambient Temperature</b>	<ul style="list-style-type: none"> <li>• Up to 40°C</li> </ul>
<b>Material</b>	
<b>Diaphragm</b>	Santoprene
<b>Piston</b>	Viton
<b>Pump house</b>	PP

## P2. Assembly Instructions and Installation

### General Dimensions (Back view)

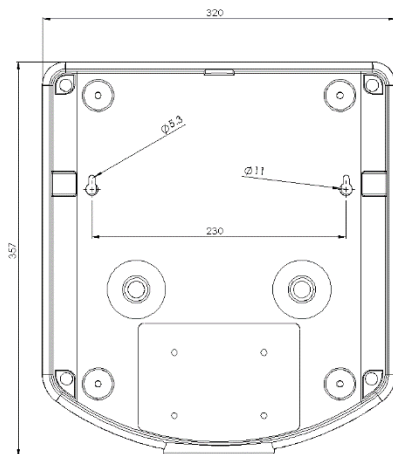

1. Position the pump vertically.
2. Pump must be installed under shelter - protected from sun and water. Avoid water splashes.
3. Make sure that filter  $\frac{3}{4}$ " (120 micron) is installed at the pump inlet.
4. Verify that check valve is positioned according to the arrow - horizontal or vertical position.

### Irrigation Controller

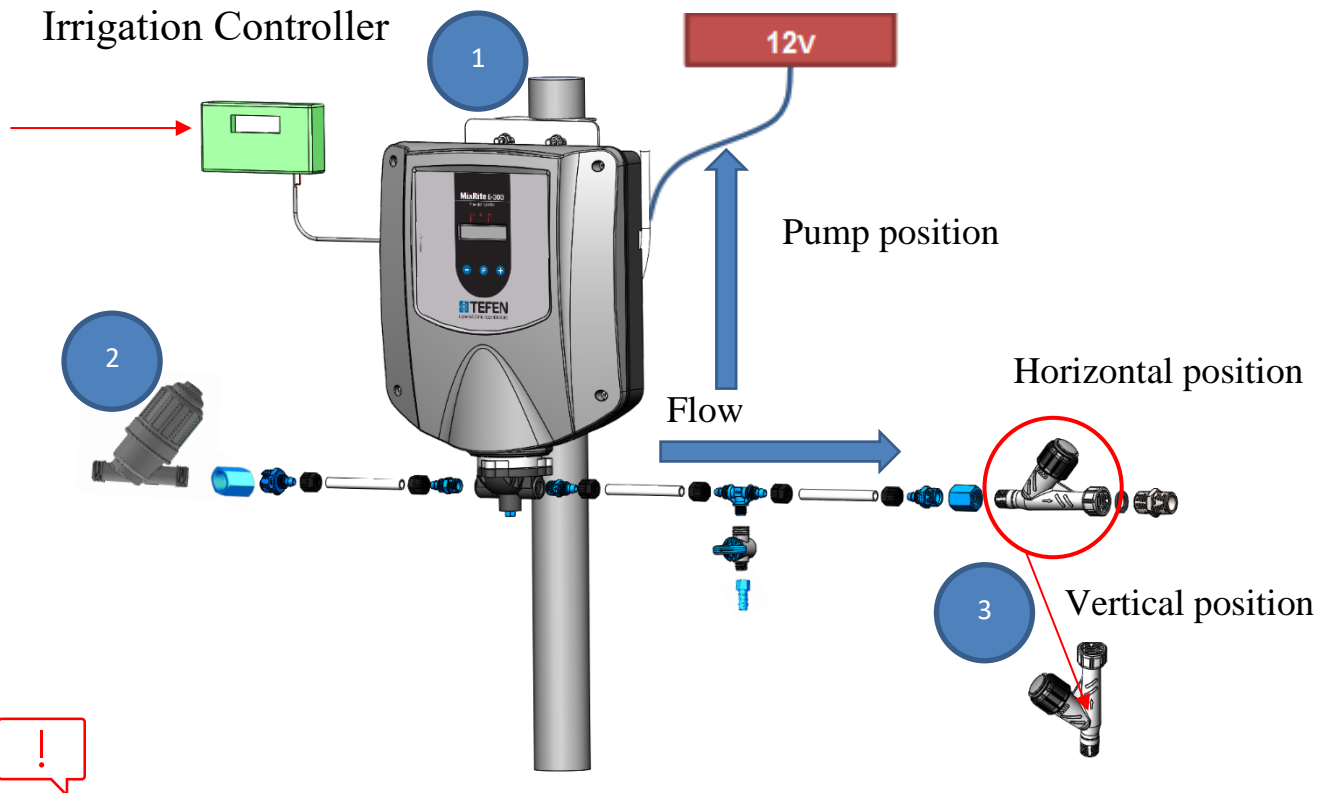

**NOTE: Only qualified electrician certificates may change the wiring of the pump**

## P3. Set Pump Parameter and Operation

- 1- Connect the pump to the power source 12V DC (Red+ and black -)– and to irrigation controller (black number 1 and 2 - Polarity does not matter)
- 2- The display will show “OFF”



### 3- Mode adjustment:

3.1- The default value is DC NC (Normally Closed) for the first activation.

3.2-Select the mode, execute the following steps:

- 1- Press the buttons as shown below:

(P)→(+ )→(P)→(+ )

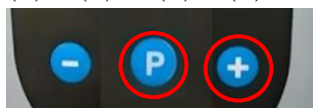

- 2- Press (P) to change mode options:

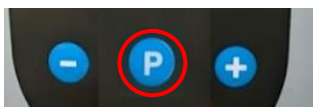

DC NC



DC NO or DC Latch



AC

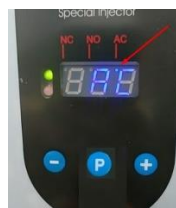

3.3 – To fix the mode press (+).



3.4- The mode will be stored.

**Note: On DC Latch mode – Initiate (one time) STOP-START-STOP procedure on your Irrigation Controller to ensure correct operation state of the pump.**

**4- Pump operation – pump value setup:**

- a- When the motor is stopped, the display shows "OFF" and when started the display shows the power value.
- b- Press (+) to increase motor power (value in percentage).
- c- Press (-) to decrease motor power (value in percentage).
- d- Press simultaneously on (+) and (-) to Start or Stop the Pump. Pump value can be changed during operation/stop.
- e- When display shows 0% the pump will turn-off automatically after 20 seconds.

**On first operation execute priming. Press (P) continuously to activate the motor at 90% power. Verify that the system contains fluid.**



**5- Operation cycle**

- a- Up to 4 bar- continuous.
- b- 4 - 5 bar - 1.5 hours-

## **P4. Troubleshooting**

There are three main causes of pump failures:

1- Display **E r 1** - 12 A Over-Current (Electrical Overload):

a- The Motor turns 'OFF' and Red light appears.

2- Display **E r 2** - 16 A Over-Current (Electrical Overload):

a- The Motor turns 'OFF' and Red light appears.

3- Display **E r 3** - Under-voltage (Driver Low voltage) supply

a- The Motor turns 'OFF' off and Red light appears.



## **P5. Maintenance**

#	Period	Maintenance Action
<b>1</b>	1 Week	Clean suction filter
<b>2</b>	2 Week	Check that the tube is clean
<b>3</b>	6 months	Clean diaphragm
<b>4</b>	6 months	Check function and noise







\* After using aggressive chemicals, it is recommended to flash the system with clean water.

## P6. Additive flow rate MixRite E-300

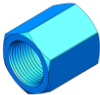
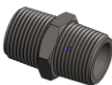
L/H	Value	Bar
19	16	4
32	20	4
64	30	4
94	40	4
125	50	4
151	60	4
168	70	4
191	80	4
234	90	4
256	100	4
0	10	5
8	20	5
39	30	5
71	40	5
98	50	5
129	60	5
150	70	5
186	80	5
214	90	5
252	100	5

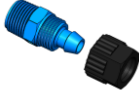
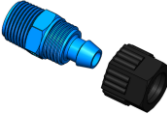
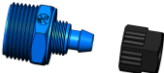
L/H	Value	Bar
21	10	1
59	20	1
94	30	1
131	40	1
166	50	1
200	60	1
228	70	1
258	80	1
291	90	1
314	100	1
21	13	2
49	20	2
86	30	2
120	40	2
153	50	2
181	60	2
205	70	2
236	80	2
266	90	2
301	100	2
19	10	3
36	20	3
72	30	3
104	40	3
140	50	3
171	60	3
189	70	3
224	80	3
245	90	3
287	100	3

## P7. MixRite E-300 STD KIT

Qty.	Descriptions	Part No.	Image
1.00	FEMALE PIPE COUPLING - 1/2"	12010308088	
1.00	FEMALE PIPE COUPLING - 3/4" BLUE	12010312128	
1.00	PIPE HEX NIPPLE - 3/4" NPT	12022212123	
10.00	PE TUBING 12 MM - NATURAL	14030052101	
2.00	MALE CONNECTOR - 12 MM*3/8"	22456852067	
1.00	MALE CONNECTOR - 12 MM*1/2"	22046852088	
1.00	MALE CONNECTOR - 12 MM*3/4"	22046852128	
1.00	MALE BRANCH TEE - 12 MM*1/4"	22047152048	
1.00	2 WAY 1/4" VALVE PP GREY	23002504043	
1.00	Line Check Valve 3/4"*1/2 MALE EPDM	23444008122	
1.00	FILTER 3/4" GREY	38000000172	

## MixRite E-300 PVDF KIT

Qty.	Descriptions	Part No.	Image
1.00	FEMALE PIPE COUPLING - 1/2" PVDF	12050308081	
1.00	FEMALE PIPE COUPLING - 3/4" PVDF	12050312121	
1.00	PIPE HEX NIPPLE - 3/4" NPT PVDF	12062212121	
10.00	PE TUBING 12 MM - NATURAL x 100 meter	14030052101	
2.00	MALE CONNECTOR - 12 MM*3/8" PVDF	22056852061	
1.00	MALE CONNECTOR - 12 MM*1/2" PVDF	22056852081	
1.00	MALE CONNECTOR - 12 MM*3/4" PVDF	22056852121	
1.00	MALE BRANCH TEE - 12 MM*1/4" PVDF	22057152041	
1.00	2 WAY 1/4" VALVE PVDF	23002904041	
1.00	Line Check Valve 3/4" * 1/2 MALE VITON	23444108122	
1.00	FILTER 3/4" GREY	38000000172	

## P8. MixRite E-300 - Spare parts

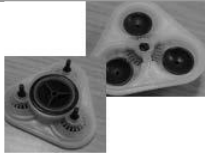
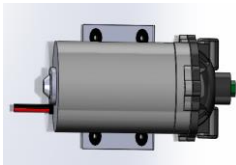
Item no	Image	Part No.	Descriptions
1		38000000273	Controller STD for electric pump
2		37SFGTF0101	ControlRite-01 - DC-Latch E-300
3		38000000356	Motor Gasket
4		38000000390	Upper Housing
5		38000000391	Valve Kit (Viton)
6		36700000004	ElectroRite Pump wired Diaphragm Pump