

Battery Operated Advanced Computerized Irrigation Controller Installation and Operating Instructions

This handbook provides the installation and operating instructions for the DC-1, DC-2 and DC-4 controllers and S series DC-1S, DC-4S, DC-6S

Main Features:

- Independent programming of each individual valve
- Weekly or cyclical programming
- Up to 4 operations per day in weekly program mode
- Irrigation duration one minute to 12 hours
- Irrigation frequency once a day to once every thirty days in a cyclical program
- Waterproof when immersed in water (IP68)
- Rain off sensor option
- Weather resistant
- Irrigation duration modifiable as a function of percentage entered
- Operation of one to 4 valves and a master valve
- Computerized "manual" operation of individual valves
- Sequential "manual" operation - optional
- Batteries: DC-1-4: two 9V alkaline batteries
- Use only alkaline batteries
- Operation temperature -10° to 70°

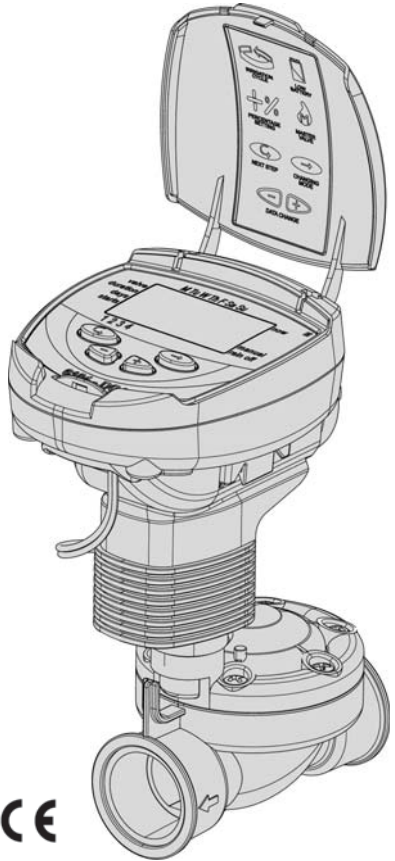

Computerized Control Systems

1 Parts Identification.....	3
2 Setting up the Irrigation Controller.....	3
2.1 Valve and Solenoid Assembly	
2.2 Manual-Mechanical Operation	
2.3 Battery Installation	
2.4 Installing the Controller in the Irrigation System	
2.5 Wiring the Solenoids	
3 Programming the Irrigation Controller.....	7
3.1 Setting the Current Time and Day of the Week	
3.2 Switching between AM/PM and 24 Hour Time Format	
3.3 Valve Selection	
3.4 Setting the Irrigation Duration	
3.5 Selecting Days of the Week for Irrigation	
3.6 Setting Irrigation Start Times	
3.7 Example: Programming a Weekly Irrigation Schedule	
4 Additional Functions.....	12
4.1 One-Time Irrigation	
4.2 Cyclical Irrigation	
4.3 Setting the Day of the Week and Time for Cyclical and One-Time Irrigation Programs	
4.4 Example: Programming a Cyclical Irrigation Schedule	
4.5 "Manual" Irrigation System Operation via the Irrigation Controller	
4.6 Sequential "Manual" Operation of all the Valves	
4.7 Suspension	
4.8 Irrigation Duration Extended or Shortened by a Specified Percentage	
5 Additional Displays.....	16
5.1 Valve in Wait Mode	
5.2 Blinking Low Battery Warning	
5.3 Permanent Low Battery Warning	
5.4 Missing Program Data	
5.5 Sensor	
6 S Series	19
6.1 Irrigation window in the Cyclical Program Mode	
6.2 Opening an Irrigation Window after Start Time has passed	
6.3 Sensor	
7 Maintenance, Troubleshooting and Repairs.....	22
8 Additional Accessories and Products.....	23
9 Table for Irrigation Planning with Galcon Controllers.....	25

1. Parts Identification

1. Cover
2. Push buttons
3. Controller display
4. Battery compartment cover
5. Adaptor
6. Mechanical operation lever
7. Solenoid
8. Hydraulic valve

Important!

Assembly of a filter upstream of the valve is mandatory.

(See list of accessories page 20).

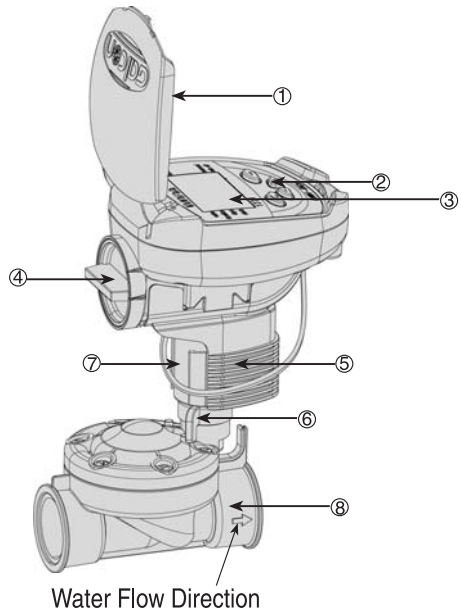

2. Setting up the Irrigation Controller

2.1 Valve and Solenoid Assembly

- 2.1.1 Shut the main irrigation system valve.
- 2.1.2 Install the hydraulic valve in the irrigation system.

Important!

It is recommended that you do not disassemble the solenoid.

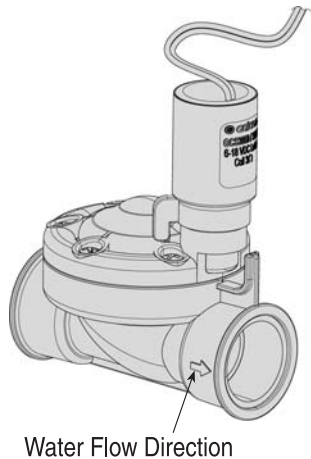

2.2 Manual-Mechanical Operation

The irrigation valve can be opened and closed independent of the controller's operation. Manual operation is useful when immediate irrigation is required, and the controller is not assembled yet.

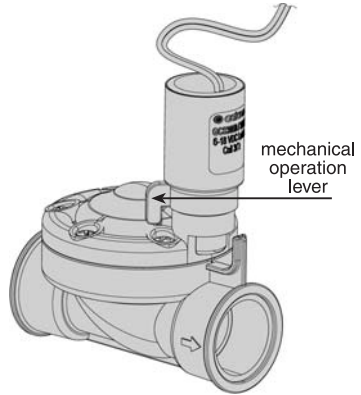
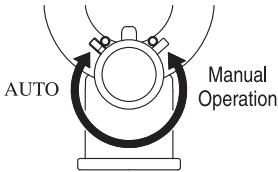

Remember! For controller operated irrigation, the valve lever must be in the middle (AUTO) position.

2.3 Battery Installation

Open the battery compartment cover. Insert 9V batteries (see illustration). All the controller display elements appear briefly on the display, followed by a blinking time of 12:00. The controller is now ready to be programmed.

Important!

Make sure to replace the battery compartment cover with the grip (see drawing) and then rotate the cover 1/8 of a turn to the right. Be sure to do so otherwise the battery cover pins might break.

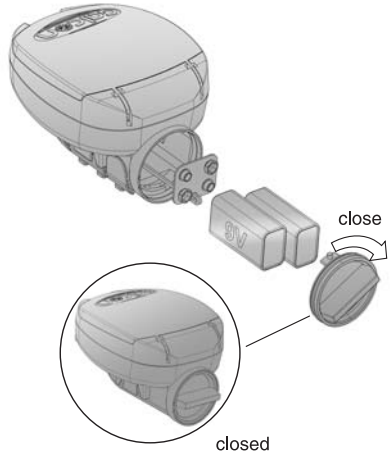

2.4 Installing the controller in the irrigation system

The controller can be installed on the solenoid or on the wall.

Installing on the solenoid

- a. Put the solenoid adaptor on the solenoid. The controller will be assembled to the adaptor with a small click.

Installing on the wall

- a. Place the mounting plate (5) on the wall using 3 screws (not included).
- b. Remove bracket (2) from controller and slide onto the mounting plate.
- c. Connect the controller to the bracket (2) by pressing.

- (1) Controller
- (2) Bracket
- (3) Solenoid adaptor
- (4) Solenoid
- (5) Mounting plate for wall

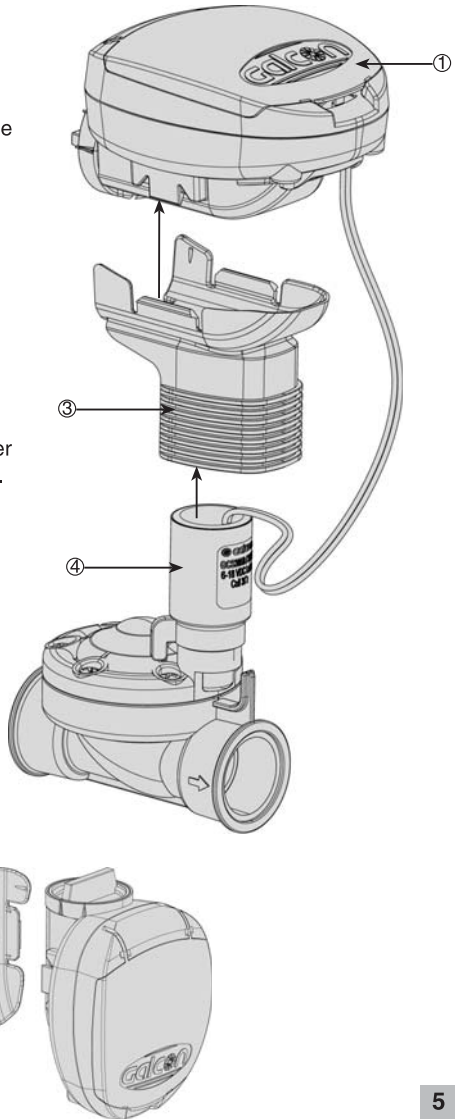

2.5 Wiring the solenoids

NOTE: Each zone requires a dedicated pair of wires from the controller.

The four and six station controllers have red and black pairs of wires numbered for each valve. Notice there are 2 extra sets of wires. One set of wires (black and red) is stamped with the letter M representing the master valve, and one set of wires (yellow) with the letter S representing the rain sensor connection. Connect each of the controller wire sets (each with red and black) to each solenoid wire (red and black).

Connect the red wire from the controller to the red wire on the solenoids and each of the black wires from the controller to each black wire on the solenoids using waterproof connectors.

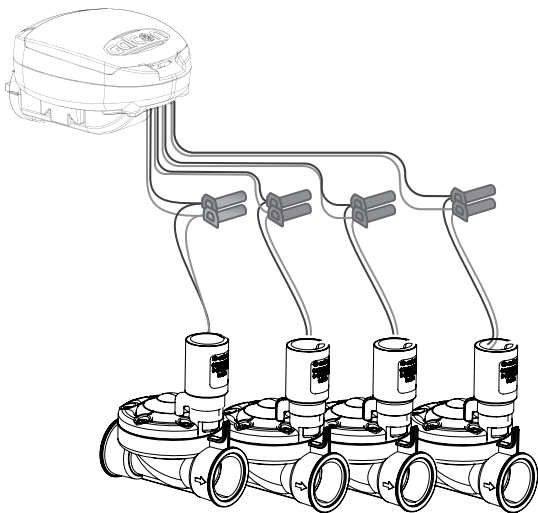

NOTE: If you install a master valve, it will open automatically with each valve. No special programming needed.

NOTE: Do not strip the master valve or sensor wires unless using master valve or rain sensor.

NOTE: The solenoid operates only with standard 2-way normally closed valves.

3. Programming the Irrigation Controller

This section describes the programming steps for a simple irrigation schedule. It is followed by a section dealing with more advanced irrigation controller operations.

The irrigation controller is programmed with the aid of 4 buttons:

- ⊖ Programming Step Selector - used to select the desired programming mode (e.g., clock setting mode)
- ⊞ Parameter Selection Button - used to select the parameter to be changed (e.g., hour, minute, etc.). The selected parameter can only be changed when its entry is blinking on the display.
- ⊕ Increment Button - increases the value of the selected parameter (e.g., when hour is selected, from 06:00 to 07:00).
- ⊖ Decrement Button - decreases the value of the selected parameter (e.g., when hour is selected, from 06:00 to 05:00).

3.1 Setting the Current Time and Day of the Week

To enable the irrigation controller to operate the irrigation system at the correct times, the current time and current day of the week must first be set.



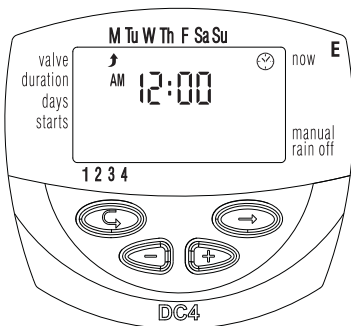

1. Press ⊖ several times until the ☺ appears.
2. Press ⊞ The hour digits blink. Set the current hour using ⊕ or ⊖ (Note the AM and PM designations).
3. Press ⊞ The minute digits blink. Set the current minute using ⊕ or ⊖.
4. Press ⊞ A blinking arrow appears at the top of the display. Move the arrow to the current day of the week using the ⊕ or ⊖ button.



If the most recent data item stops blinking before you finish programming it, press ⊞ to continue the programming process.

3.2 Switching between AM/PM and 24 Hour Time Format

The default time format is AM/PM. There is also a 24 hour time format. To switch between the two formats:

1. Press  until the  appears.
2. Press . The hour digits blink.
3. Press  and  simultaneously. The clock reading switches from AM/PM to a 24 hour time display or vice versa.



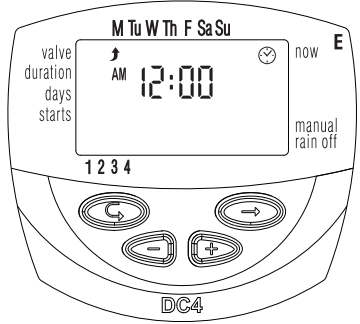



You can switch the time display format at any step in the programming process.



3.3 Valve Selection

This section does not apply to the DC-1 model.





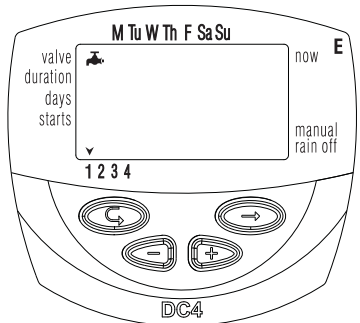



Program an irrigation schedule for each valve individually. First select the desired valve, and then program a schedule as follows:

1. Press  until  appears.
2. Press . A blinking arrow appears at the bottom of the display.
3. Move the arrow to the desired valve number by pressing  or .
4. Press  to proceed to the next step.



3.4 Setting the Irrigation Duration





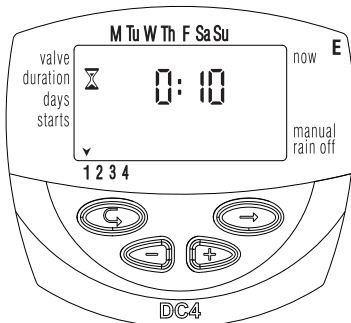





This setting determines how long the irrigation lasts.

1. Press  until  appears.
2. Press . The hour digits blink. Set the desired number of hours by pressing  or . Press  again - the minute digits blink. Set the desired number of minutes by pressing  or .
3. Press  to proceed to the next step.



3.5 Selecting Days of the Week for Irrigation





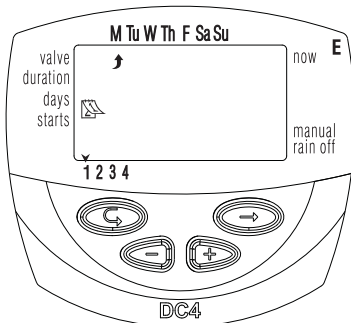



This setting determines which days of the week the irrigation controller will operate the specified valve.

1. Press  until  appears.
 2. Press . A blinking arrow appears at the top of the display, under Monday.
 3. Move the blinking arrow to the desired day of the week by pressing .
 4. Selecting/adding irrigation days: Press . The arrow under the selected day stops blinking, moves one position to the right, and blinks under the next day of the week. You can select additional days of the week in the same manner.
 5. Canceling Scheduled Irrigation Days: Have the arrow blink under the day you want to cancel. Press . The arrow under the selected day will disappear. The blinking arrow will move one position to the right, under the next day of the week. Cancel additional scheduled irrigation days in the same manner.
 6. Press  to proceed to the next step.
- When the blinking arrow reaches Sunday, pressing  again displays OnCe in the center of the display, and  at the top right of the display. To return to the "Selecting/Adding Irrigation Days" mode, press  once or twice.



3.6 Setting Irrigation Start Times

In this step, up to 4 separate irrigation start times can be programmed for a selected day for the valve being programmed. The selected valve will open at each of the start times set, for the irrigation duration set as described in Section 3.4.

1. Press  until the **START I** appears.
The word **OFF** or the last start time set will appear on the display.
2. Press . The displayed item blinks (**OFF** or last start time entered).
3. Set the desired start time by pressing  or . (Take note of the AM and PM designations). Repeat actions 2 and 3 to set start times **II**, **III** and **IV**, as needed.
4. To cancel a specific start time, select it by pressing . Next, press . The hour digits blink. Press  or  until the word **OFF** appears on the display.
5. To program another valve, select it, and repeat the above steps, starting from section 3.3 above.

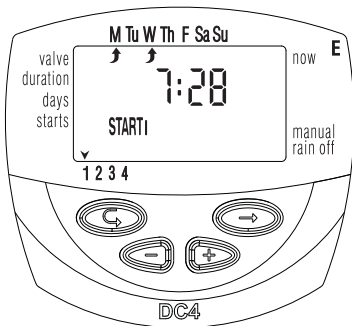





























3.7 Example: Programming a Weekly Irrigation Schedule

Let's assume you want to program the irrigation controller to water three times a day using the 24 hour time display format: at 08:00 AM, 13:00 PM and 19:00 PM, for 21/2 hours at a time, on Tuesday and Friday.

To switch to an AM/PM time display format, see section 3.2.

(If you are using a DC-1 model irrigation controller, start from step 4 below.)





1. Press  until  appears.
2. Press . A blinking arrow appears at the bottom of the display.
3. Press  or  to move the arrow to the valve number to be programmed.
4. Press  until  appears.
5. Press . The hour digits blink. Press  or  until the hour displays 2. Press . The minute digits blink. Press  or  until the minute displays - 30.
6. Press .  appears.
7. Press . A blinking  appears at the top of the display, under Monday. Press  until the blinking arrow appears under Tuesday, and then press . The arrow under Tuesday will stop blinking and advance one position to the right, to Wednesday. Press  twice to move the arrow to Friday, and then press .
8. Press . START I time appears. Press . The hour digits blink.
9. Set the start time to 08:00 by pressing  or . Repeat this step to set START II time [2] to 13:00 and START III time [3] to 19:00.
10. Press . START IV time [4] appears. Press . The hour digits blink.
11. Press  or  until OFF appears. The fourth opening of the valve is canceled.

4. Additional Functions

4.1 One-Time Irrigation

This function is used to program the irrigation controller to operate the irrigation system once only, for the set irrigation duration, at the set time.

(Duration set as described in Section 3.4).



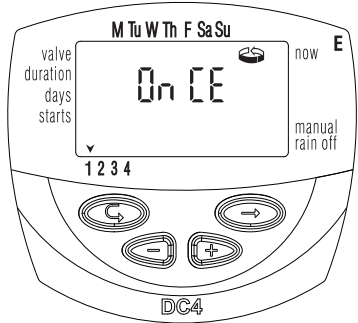



1. Press  until  appears.
2. Press  several times (for all the days of the week) until  appears, and  blinks on the display.
3. Go to Section 4.3 to set the day and time.



4.2 Cyclical Irrigation

This option is used to program the irrigation controller to operate the irrigation system in a cyclical manner, once every x days, for the irrigation duration.

(Note: Duration for which valve stays open set as described in Section 3.4).



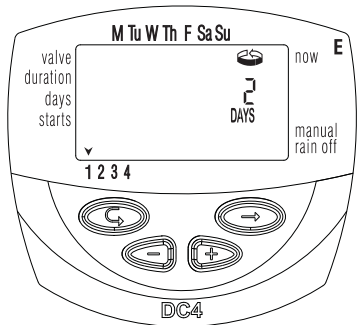



1. Press  until  appears.
2. Press  several times (for all the days of the week) until  appears, and  blinks on the display.
3. With the display blinking, press  or . The interval between irrigation sessions (irrigation cycle) in days, hours or minutes is displayed. For example, if you set 2 days, the irrigation will be performed every two days for the defined duration.

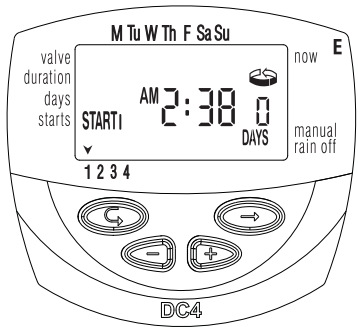

4.3 Setting the Day of the Week and Time For Cyclical and One-Time Irrigation Programs













These programs enable you to pre-set the time of valve opening. The number of days until the valve opening appears on the display, to the right of the irrigation start time (above the word "days"). 0 days = program starts today; 1 day = program starts tomorrow, etc. (up to 30 days).



1. Press  until START I appears. The last opening time entered appears on the display.
2. Press . The hour digits blink.
3. Set the desired opening time by pressing  or  (Take note of AM and PM designations).
4. Press  until the digit to the right of the opening time blinks (The digit above the word "days").
5. Set the number of days until the opening of the valve by pressing  or .
 - Valve openings 2, 3 and 4 are canceled in this mode.

4.4 Example: Programming a Cyclical Irrigation Schedule









Let's assume you want to program the irrigation controller to open the valve at 12:45 PM, for a period of one hour, every 5 days.

1. Set the irrigation duration as described in Section 3.4: Setting the Irrigation Duration. (Press  until  appears, then set the desired irrigation duration by pressing  or .
2. Press  until  appears.
3. Press  a number of times (for all the days of the week) until On CE appears blinking on the display.
4. While the display is still blinking, press  or  until "5 days" appears on the display, representing the irrigation frequency.
5. Press . START I is displayed.
6. Press . The hour digits blink.
7. Press  until the hour digits change to 12 (PM).
8. Press  until the minute digits change to 45.

4.5 "Manual" Irrigation System Operation via the Irrigation Controller

This function operates the selected valve for the irrigation duration defined in the program. The valve will close automatically at the end of the irrigation duration.



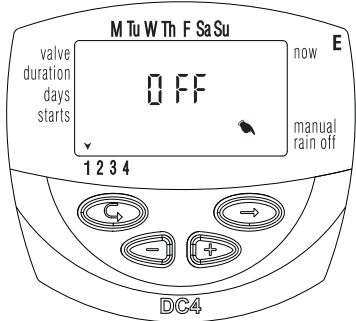
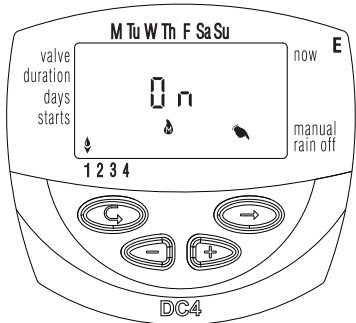

Note that the originally programmed irrigation schedule continues to operate at the set times.

1. Press  until  appears. Select one or more valves as described in Section 3.3: "Valve Selection".
 2. Press  until  appears.
 3. Press  to open the valve. The word "On" is displayed. After an interval of 5 seconds, a count down of the remaining irrigation duration appears on the display. To close the valve manually, press .  FF appears on the display.
 4. To close the valve manually before the end of the irrigation duration, press  until ON appears again on the display. Press  to close the valve.
- Up to two valves can be operated simultaneously in this manner. Simply repeat the above steps for the second valve.



4.6 Sequential "Manual" Operation of all the Valves

The valves can be operated sequentially, one after the other.





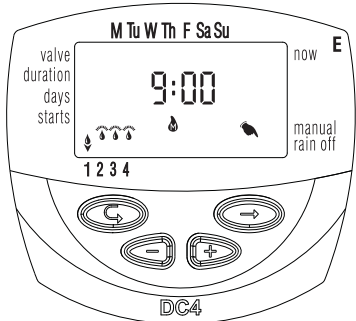



1. Press  until the  appears.
2. When nothing is blinking on the display, press and hold down  for 5 seconds. Valve 1 will open and operate for the programmed irrigation duration. When valve 1 closes, valve 2 opens, and so forth until the last valve has opened. All the valves designated to open blink.
3. You can control the process. Pressing  closes the current valve and opens the next one.

Important: You can only exit this screen after all the valves have opened.



4.7 Suspension

This option is used to temporarily suspend the irrigation controller's control of the valves, for example, while it is raining. The irrigation schedule remains stored in the controller, but is not implemented. The suspension option disables ALL valves connected to the irrigation controller.



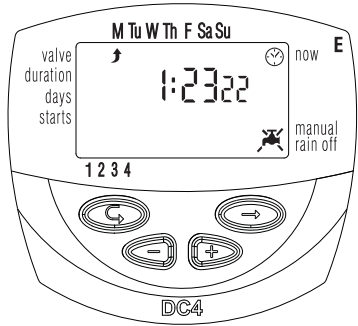





1. Press  until the  appears.
2. Press and hold down  for 5 seconds.  appears blinking alongside the word "rain off". The controller is now suspended.
3. To restore control to the controller, press  until the  appears, and then press and hold down  until the  disappears.
4. Suspension can also be implemented while a valve has been activated.
5. If an attempt is made to operate a valve manually while the irrigation controller has been suspended, or when a valve is meant to open sequentially, the word "rAin" appears on the display, and the valve will not open.



4.8 Irrigation Duration Extended or Shortened by a Specified Percentage

You can extend / shorten the irrigation duration for all the valves simultaneously by specifying a percentage for the duration.

Example: if the irrigation duration has been set to one hour, adding 10% extends the duration by 6 minutes (to 66 minutes).

1. Press  until the  appears.
2. Wait until no digit is blinking
3. Press  and  simultaneously. 00+% is displayed.
4. Press . The 00 blinks. Press  or  to increase or decrease the percentage as necessary (in increments of 5%). +% or -% is permanently displayed on the main  display, accordingly.

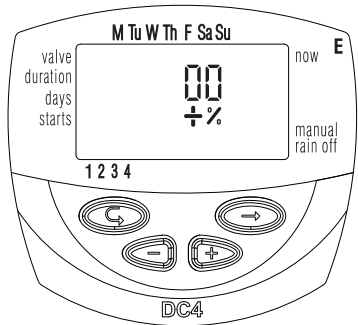

Important! The percentage cannot be changed for an individual valve.

5. Additional Displays

5.1 Valve in Wait Mode

This section does not apply to the DC-1 Model.

When two valves are currently open, and a third valve is scheduled to open, the third valve enters into wait mode. A blinking  appears above the number of the waiting valve. When one of the first two valves closes, the waiting valve opens. During "manual" operation of a waiting valve via the irrigation controller, the letter "W" (Wait) appears on the display. The valve opens when another valve closes.

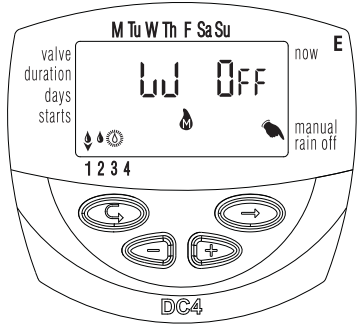

5.2 Blinking Low Battery Warning

When the batteries are low, a blinking battery icon appears on the display. In this state, the batteries still enable valve operation, but must be promptly replaced.

After replacing the batteries, press any button to resume irrigation controller operation. Programmed data are retained if batteries are replaced within 30 seconds.

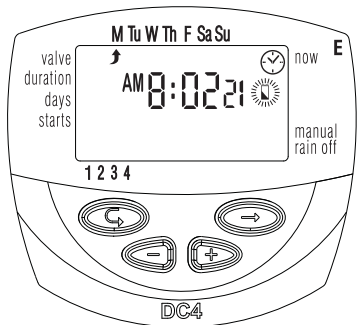

5.3 Permanent low battery warning

When the batteries are low and not replaced in a timely manner, the battery icon is permanently displayed. All other display elements disappear, all valves will close and all programs will disappear. Replace batteries promptly and reprogram the controller. Programmed data are retained if batteries are replaced within 30 seconds.

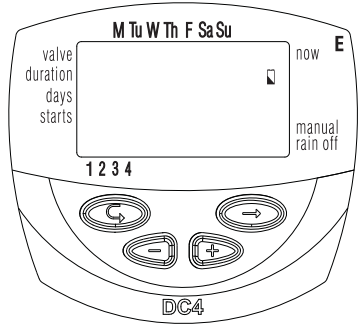

5.4 Missing Program Data

During "manual" operation via the irrigation controller `no Prog` appears on the display (see Section 4.6: "Manual Irrigation System Operation"), indicating that no irrigation duration has been set for the specified valve. In this case, opening of the valve is disabled.

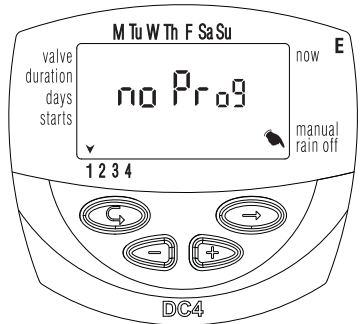

5.5 Sensor

The irrigation controller offers advanced irrigation control using a rain off sensor. That is, as long as the conditions defined for activation of the sensor are not met, the irrigation schedule will not be implemented. (The rain off sensor contact remains closed). For example, if a rain sensor is connected to the irrigation controller, irrigation takes place as long as the sensor remains dry. In the event of rainfall, the sensor prevents the opening of all the valves associated with it.

There is also the option of using any type of dry contact sensor N.O. When the sensor contact is closed all valves will close and no irrigation will take place (diagram page 6).

As long as the sensor closes the circuit (i.e., the sensor detects the existence of a defined program lockout condition) the symbol  blinks on the display and irrigation will not take place through any valves associated with the sensor. The display will show "S OFF" when the controller is in manual operation. This means the sensor is activated and prevents the irrigation.

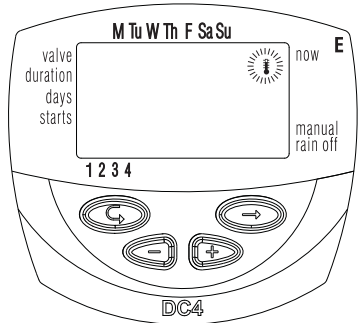
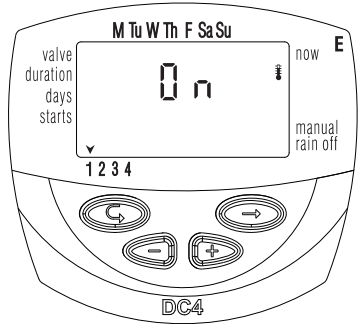

6. Additional Instructions for “S” Series DC-1S, DC-4S, DC-6S

Main Features:

- Irrigation duration in professional controllers of the "S" series: one second to 12 hours
- Irrigation frequency in professional controllers of the "S" series: once every minute to once every 30 days in the cyclical program
- Irrigation window in cyclical program mode in the professional controllers of the "S" series.

Setting the Irrigation Duration

In professional controllers -"S" series, the duration of the irrigation can also be programmed in seconds.

The method of programming is the same.

Cyclical Irrigation

In the "S" series of professional controllers, the irrigation cycle can be programmed from one minute up. The settings are performed in the same manner.

6.1 Irrigation Window In the Cyclical Program Mode

The irrigation window function is incorporated in the "S" series of professional controllers. The irrigation window is an advanced feature which enables you to define that the operations in a cyclical irrigation program (see Section 4.2) be performed during a specified part of the day only (window). An irrigation window can only be defined for an irrigation cycle that is shorter than a full day (up to 23.59 hours), and only in the cyclical irrigation mode. If the irrigation cycle exceeds 24 hours, the window function is disabled. This function is useful, for example, when irrigation is only required during the hot hours of the day.

1. Press until appears on the display next to W. OPEN. The word OFF or the last OPEN WINDOW time setting entered is displayed.
2. Press . The word OFF blinks on the display.
3. Press and to set the desired OPEN WINDOW time (pay attention to the AM/PM designation).
4. Press until appears, with 12:00 AM or the last CLOSE WINDOW time setting displayed.
5. Press and to set the desired CLOSE WINDOW time (pay attention to the AM/PM designation).

* If an irrigation cycle exceeding 24 hours has been programmed, the irrigation window function is disabled.

To cancel the irrigation window

1. Press until appears next to OPEN WINDOW, along with the display of the last OPEN WINDOW time setting entered.
2. Press . The irrigation window open time blinks on the display.
3. Press until Off appears next to . The irrigation window is now cancelled.

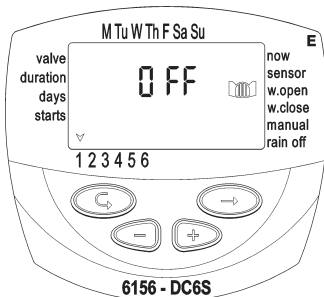
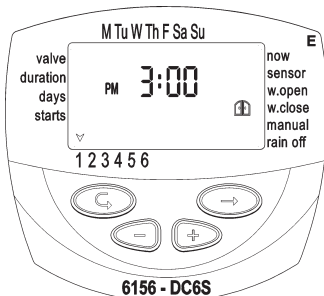
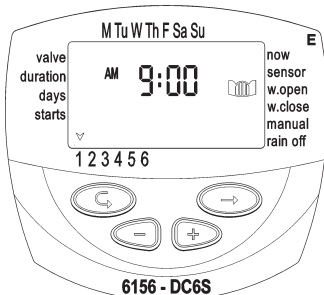

6.2 Opening an Irrigation Window after Start Time has passed

Example: You are setting an irrigation program specifying 5 minutes of irrigation every 30 minutes, from 9:00 AM to 5:00 PM. However, you have entered the settings at 9:20 AM. As a result, the program will not commence today, but only from 9:00 AM tomorrow. To force the program to begin today, perform the following steps:

1. Press \ominus until START I is displayed.
2. Press \oplus and \ominus to set any time after the current time: e.g. 9:30 AM. This time will constitute the first start time for today.

From tomorrow, the schedule will operate according to the program you set. The Start I display will display the next start time taking into account the window you have set.

6.3 Sensor

In the “S” series each valve must be associated to the sensor, as needed.

1. Select the valve to which you want to associate the sensor.
2. Press \ominus until \mathbb{I} appears alongside the word SENSOR.
3. Press \oplus to activate the sensor in the irrigation program for the selected valve.

The word On is displayed.

As long as the sensor closes the circuit (i.e., the sensor detects the existence of a defined program lockout condition) the symbol \mathbb{I} blinks on the display and irrigation will not take place through any valves associated with the sensor.

Press \ominus to disable the sensor. The word “OFF” appears on the display.

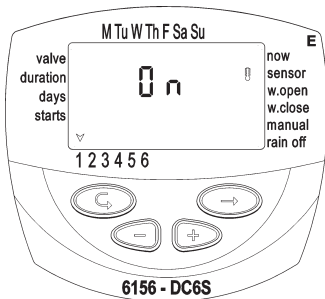

7. Maintenance, Troubleshooting and Repairs

- Batteries should be removed if the irrigation controller is not going to be used for a lengthy period. The programs will disappear when removing batteries. Again reprogram the controller.
- A filter must be installed upstream of the valve or system of valves and cleaned every few months. Operation without a filter is liable to lead to malfunctions.
- Under normal usage, batteries (Alkaline) last at least a year.
- Do not run water through an irrigation line unless a solenoid is fitted on the hydraulic valve.
- Recommended water pressure: 1-8 ATM (bar).

Problem/Event	Cause	Solution
Valve does not open during Automatic operation or during "Manual" operation via irrigation controller	The connection between the controller and the solenoid is not good	Disconnect the solenoid from the controller and reassemble
	Batteries not working	Replace batteries
No display	Batteries not working	Replace batteries
Valve stays open even though the lever is in AUTO position	The solenoid is open	Connect the controller to the valve, insert batteries, close and open manually via the controller
Valve does not close, despite click heard during activation	Valve lever not in AUTO position.	Move valve lever to AUTO position
	Dirt and scale in valve mechanism	Clean or replace valve

8. Additional Accessories and Products

8.1 General

Lockable protective box
Line Filter, BSP 3/4"
Line Filter, BSP 1"
Waterproof connector
Extension cable for solenoid cables

8.2 Two-way (2W) Controllers

Valve + DC solenoid from Galcon:

2W 3/4" (valve + solenoid)
2W 1" (valve + solenoid)
2W 1 1/2" (valve + solenoid)
2W 2" (valve + solenoid)
2W DC Solenoid Only
3/4" (Valve + 2W adaptor)
1" (Valve + 2W adaptor)
1 1/2" (Valve + 2W adaptor)
2" (Valve + 2W adaptor)

Date: _____

Valve No.	The irrigation/vegetation area (window box, porch balcony, lawn)	Irrigation Program		Irrigation Duration (minutes, hours)	Daily start times			
		Weekly	Cyclical		1	2	3	4
1		M, Tu, W, Th, F, Sa, Su			1	2	3	4
2		M, Tu, W, Th, F, Sa, Su						
3		M, Tu, W, Th, F, Sa, Su						
4		M, Tu, W, Th, F, Sa, Su						
5		M, Tu, W, Th, F, Sa, Su						
6		M, Tu, W, Th, F, Sa, Su						



LIMITED WARRANTY CERTIFICATE

1. Galcon shall, for a limited period of 36 months from the retail purchase date of the original (first) purchaser (“**the Warranty Period**”), provide limited warranty for the Products, as provided for and subject to the provisions and limitations of this Limited Warranty Certificate.
2. Galcon’s Warranty for the Product only extends to the original purchaser of the Product (“**the Customer**”) who, upon requesting warranty service, must present Galcon with a valid purchase receipt. Failure to produce the said documentation will result in the request for warranty being null and void.
3. GALCON warrants to the Customer that the Product shall materially conform to the description in Galcon’s documentation and shall be free from defects in material and workmanship. Accordingly, Customer’s sole and exclusive remedy under this warranty is the repair or – to Galcon’s sole discretion – the replacement of the Product or any part/s according to the terms of this Warranty, and no other remedy shall be available. Therefore, if - within the Warranty Period - the Product is proven to be defective by reason of faulty workmanship or materials by Galcon, Galcon undertakes, with reasonable promptness, to have the defective Product (or any part/s thereof) repaired, or at Galcon’s discretion, replaced; All subject to the terms and conditions of this Limited Warranty Certificate.
4. Galcon’s warranty for the Product or otherwise shall not apply to any of the following: (i) any conduct (by act or omission) not by Galcon, including any misuse/abuse of any Product (or part/s thereof), and/or any failure to install and/or use any Product in full compliance with Galcon’s instructions; (ii) other systems/components/devices/technologies and/or the integration/interface thereof with any Product; (iii) any part/component which has been included/installed in any Product not at Galcon’s approval and/or other than by Galcon; (iv) any actual or attempted change/repair/interference of/with any Product (including any use/handling of, and/or interference/dealing with, any code of any software included/used in the Product) other than by Galcon; (v) any data/information/content which has been inserted/included in a Product; (vi) malfunction or damage resulting from accidents, which occur during transit and/or handling, and/or malfunction or damage due to fire, earthquake, flood, lightning and/or any other external disaster; (vii) unforeseen accidents, wear and tear, or any other external factors beyond Galcon’s reasonable control, or to any Product installed, repaired, adjusted, rebuilt, modified, changed or converted by any person (including the Customer) other than Galcon;
5. In addition and without derogating from the provisions of this Warranty, Galcon’s warranty is conditioned upon the all of the following taking place: (i) Customer’s operating and maintaining the Product in accordance with Galcon’s instructions; (ii) Customer’s not being in default of any payment obligation to the Galcon (or its authorized dealer, as relevant).

6. Galcon does not give any warranty or guarantee whatsoever in respect of any Product (or any part/s thereof) which has not been manufactured and distributed by the Galcon and which has not been purchased from the Galcon or any of its authorized dealers, whether such products are branded with any trademarks similar to any trademark belonging to or used by Galcon.
7. After replacement or repair of the Product, the Warranty for the new or repaired Product shall be valid only for the non-expired period of the original Warranty Period. Any defective Products or part/s, which has been replaced, shall become Galcon's property.
8. Galcon reserves the right to charge the Customer if any warranty service is requested and carried out but no fault is found in the Product or if such defect/fault is not under Galcon's Warranty.
9. Notwithstanding anything to the contrary, Galcon shall not be responsible and/or liable, under any circumstances and in any way, for any loss, damage, costs, expenses, expenditures, responsibility and/or liability (including of Customer and/or any third party) – including (without limitation) direct and/or indirect (including incidental and/or special and/or consequential), however arising, including in respect of damages to or loss of property and/or equipment, loss of profit, loss of use, loss of revenue or damages to business or reputation, whether or not based on breach of contract, tort (including negligence), product liability or otherwise - arising from the performance or non-performance of any aspect of the Product or any part thereof; All of the above, whether or not Galcon and/or the Customer shall have been made aware of the possibility of such loss.
10. In any event, any liability which Galcon may have in connection with the Product and/or this Warranty, including (without limitation) in connection with and/or resulting from the Product (or any part thereof) and the use thereof, shall be limited to a total amount (for all damages, claims and causes of action in the aggregate) equal to the consideration actually received by Galcon from the Customer for the Product. The limitations shall apply whether the liability is based on contract, tort, strict liability or any other theory.
11. This Warranty and the remedies set forth herein are exclusive and in lieu of all other warranties, remedies and conditions, whether oral, written, statutory, express or implied. Galcon specifically disclaims any and all statutory or implied warranties, including, without limitation, warranties of merchantability and fitness for a particular purpose and warranties against hidden or latent defects.
12. The Customer shall be solely responsible for the selection, use, efficiency and suitability of the Product(s).
13. The provisions of this Limited Warranty Certificate shall be interpreted and governed, solely and exclusively, pursuant to the laws of the State of Israel, and no other law shall apply. Any and all legal actions shall be litigated within the jurisdiction of the courts of Israel, and no other jurisdiction shall apply.



Computerized Control Systems

Kfar-Blum 1215000 Tel. 972-4-690-0222 Fax.972-4-690-2727
[http://:www.galconc.com](http://www.galconc.com) E-mail: info@galconc.com