



Battery Operated Advanced Computerized Irrigation Controller Installation and Operating Instruction

This handbook provides the installation and operating instructions for the DC-1 and DC-4 controllers, and for the "S" series of professional controllers: DC-1S, DC-4S, DC-6S, DC-9S, DC-12S

Main Features:

- Independent valve programming of each individual
- Weekly or cyclical programming
- Up to 4 operations per day in weekly program mode
- Irrigation duration in DC-1 and DC-4 models: one minute to 12 hours
- Irrigation duration in professional controllers of the "S" series: one second to 12 hours
- Irrigation frequency in DC-1 and DC-4 models: once a day to once every thirty days in a cyclical program
- Irrigation frequency in professional controllers of the "S" series: once every minute to once every thirty days in the cyclical program
- Irrigation window in cyclical program mode in the professional controllers of the "S" series
- Waterproof when immersed in water: DC-1, DC-4 and DC-6S models
- Weather resistant - all models
- Irrigation duration modifiable as a function of percentage entered
- Operation of one to 12 valves and a master valve.
- Computerized "manual" operation of individual valves.
- Sequential operation.
- Batteries:
 - DC-1-4-6S and DC-1S-4S-6S models: two 9V alkaline batteries
 - DC-9S and DC-12S models: four 9V alkaline batteries
- Operation of remote valves up to 50m from the controller - in DC-4L, DC-6S, DC-9S and DC-12S models.

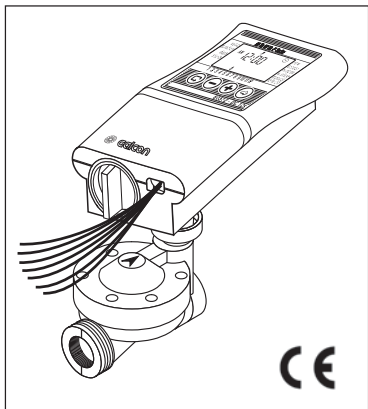

1	Parts Identification.....	3
2	Setting up the Irrigation Controller.....	3
	2.1 Valve and Solenoid Assembly	
	2.2 Manual-Mechanical Operation	
	2.3 Battery Installation	
	2.4 Installing the Controller in the Irrigation System	
	2.5 Wiring the Solenoids in the DC-4, DC-4S and DC-6S Models	
	2.6 Assembly Instructions for the DC-9S-12S Models	
3	Programming the Irrigation Controller.....	9
	3.1 Setting the Current Time and Day of the Week	
	3.2 Switching between AM/PM and 24 Hour Time Format	
	3.3 Valve Selection	
	3.4 Setting the Irrigation Duration	
	3.5 Selecting Days of the Week for Irrigation	
	3.6 Setting Irrigation Start Times	
	3.7 Example: Programming a Weekly Irrigation Schedule	
4	Additional Functions.....	14
	4.1 One-Time Irrigation	
	4.2 Cyclical Irrigation	
	4.3 Setting the Day of the Week and Time for Cyclical and One-Time Irrigation Programs	
	4.4 Irrigation Window In the Cyclical Program Mode	
	4.5 Opening an Irrigation Window after Start Time has passed	
	4.6 Example: Programming a Cyclical Irrigation Schedule	
	4.7 "Manual" Irrigation System Operation via the Irrigation Controller	
	4.8 Sequential "Manual" Operation of all the Valves	
	4.9 Suspension	
	4.10 Irrigation Duration Extended or Shortened by a Specified Percentage	
5	Additional Displays.....	20
	5.1 Valve in Wait Mode	
	5.2 Blinking Low Battery Warning	
	5.3 Permanent Low Battery Warning	
	5.4 Missing Program Data	
	5.5 Sensor	
6	Maintenance, Troubleshooting and Repairs.....	24
7	Additional Accessories and Products.....	25

1. Parts Identification

1. Top Cover
2. Controller display
3. Bottom cover
4. Battery compartment cover
5. Connecting cables to solenoids
6. Solenoid
7. Mechanical operation handle
8. Bayonet adapter
9. Water flow direction arrow
10. Hydraulic valve

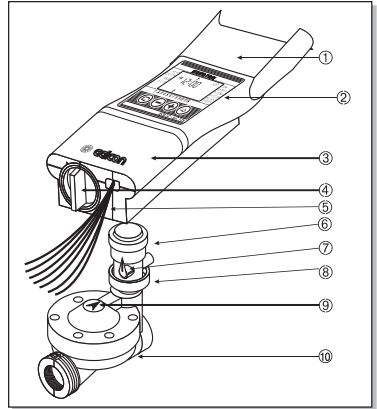

Important!

Assembly of a filter upstream of the valve is mandatory.

(See list of accessories near the end of this handbook).

2. Setting up the Irrigation Controller

2.1 Valve and Solenoid Assembly

- 2.1.1 Shut the main irrigation system valve.
- 2.1.2 Installing the hydraulic valve in the irrigation system. Pay attention to the correct water flow direction, as indicated by the arrow [4] on the valve.
- 2.1.3 If necessary, remove the solenoid [1] from the bayonet adapter by making a quarter turn to the left.

Note: Be careful not to lose the seal (O-ring) [3].
- 2.1.4 After installing the hydraulic valve [5], assemble the solenoid (if you removed it) by making a quarter turn to the right. Be sure to correctly position the seal (O-ring) [3] in place.

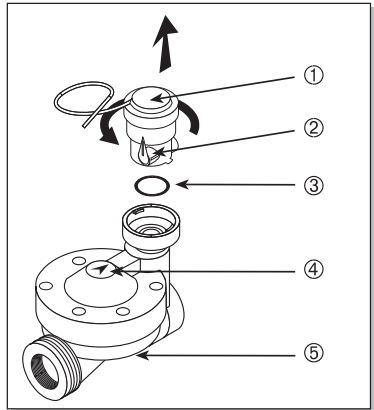

Important!

It is recommended that you do not disassemble the bayonet adapter.

2.2 Manual-Mechanical Operation

The irrigation valve can be opened and closed independent of the controller's operation. Manual operation is useful when immediate irrigation is required, and there is insufficient time or knowledge to program the controller. The valve handle is located on the solenoid, and has three positions: Open, Automatic [AUTO] and Closed.

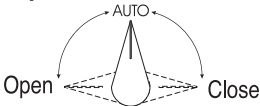

Remember! For controller operated irrigation, the valve handle must be in the middle (AUTO) position.

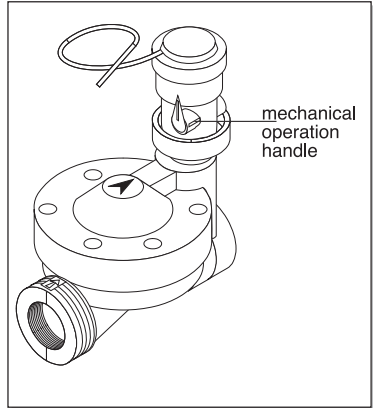

2.3 Battery Installation

Open the battery compartment cover. Insert batteries (see illustration). All the controller display elements appear briefly on the display, followed by a blinking time of 12:00. The controller is now ready to be programmed.

Important!

Make sure to replace the battery compartment cover with the grip aligned with the left arrow, and then rotate the cover 1/8 of a turn to the right.

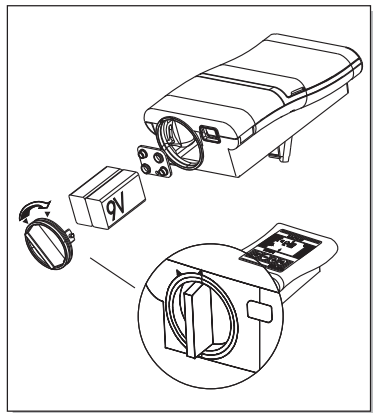

2.4 Installing the Controller in the Irrigation System

If the mounting plate [2] is attached to the back of the controller, remove it.

1. Insert the mounting coupling [1] in the rectangular opening on the mounting plate, aligning the word "TOP" imprinted on both the coupling and the plate.
2. Press the mounting plate, with the mounting coupling inserted in it, against the back of the irrigation controller and push upwards.

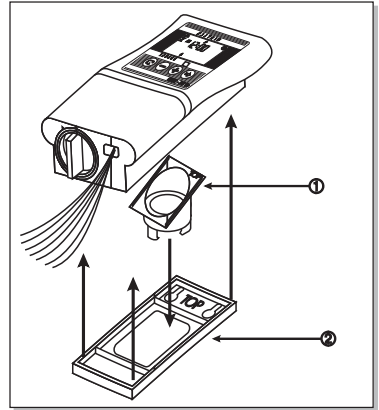

The controller mounting plate [2] can be mounted on a wall using two screws (not included in the kit), in which case the mounting coupling [1] is not used. The distance between the controller and the solenoid is limited by the length of connecting cable between them.

2.5 Wiring the Solenoids in the DC-4, DC-4S and DC-6S Models

In the DC-4, DC-4S and DC-6S models, connect the valves to the cables emerging from the controller according to the illustration and explanation below.

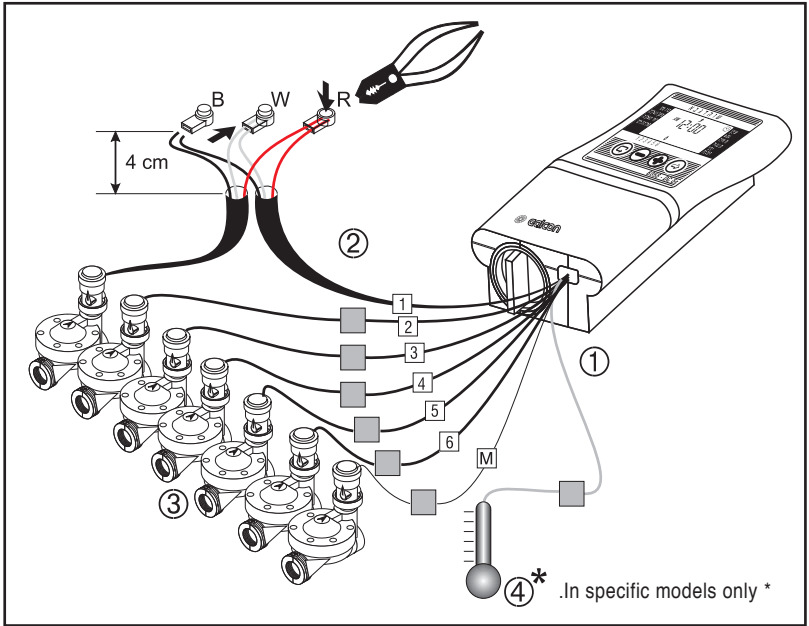

Labeled cables emerge from the controller [1]. The end of each cable is protected by a cover that must be removed prior to connecting the cable. The cables are specifically designed to connect to Galcon DC type irrigation valves and solenoids [3].

The controller and its connections are waterproof. To safeguard the waterproof characteristics, compliance with the following is essential:

- Do not remove protective covers from cables that are not connected to valves. Exposed cable ends can short-circuit with each other or with conducting bodies.
- Connect the cables to the valves (3) using the special waterproof connectors (2) supplied with the product. See illustration.

1. Cut away the covering from the controller cable (1) near the end of the cable and expose the cable leads from the black insulation. The solenoid cables have three wires: white, red and black. Do not expose the three wires from their colored insulation.

2. Connect each of the wires to a waterproof connector (2).
 3. Three wires emerge from each of the solenoids: white, red and black. Cut the entire exposed segment of the wires. Connect the white wire from the solenoid to the same to connector which you connected the white wire from the controller, and apply pressure to the red protruding part of the connector with a pliers until it is aligned with the base. Connect the other wires in the same manner: red with red, and black with black. See the illustration.
 4. Connect as many of the other controller cables to solenoid cables as there are valves in the system. Make sure that each valve number matches the number on the cable emerging from the controller.
 5. Do not lengthen the cable wires except in the DC-4L and DC-6S, 9S, 12S models.
 6. In the DC-4L and DC-6S, 9S, and 12S models, solenoids can be connected up to a distance of 50m. The cables used must be identical to the solenoid cables. The connections are made in the same manner.
- The grey cable (4) connects to the sensor and comes with the DC-1S, DC-4S and DC-6S models only.

2.6 Assembly Instructions for the DC-9S-12S Models

1. Open the controller housing hinged cover using the enclosed key (Figure 1).
2. To access the connection panel and the screw holes, open the controller panel by releasing the lock screws on the controller's left side, under the main cover (Figure 1).
3. Mount the controller to the wall or to the control closet by inserting the mounting screws through the holes indicated (Figure 2). Cover the crews with the 3 supplied caps (Figure 2)..

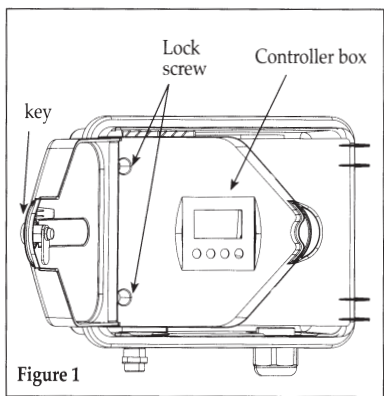
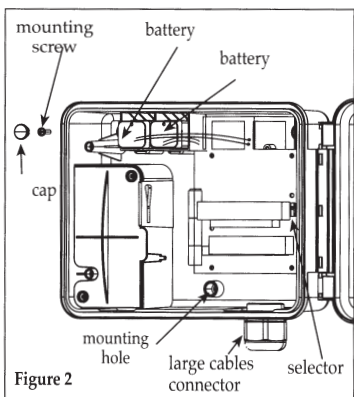

4. Installing the batteries:

Install four 9V alkaline batteries.

Two batteries to the expansion connector.

Two batteries to the main connector.

Always install the batteries for the expansion connector first.

5. Connecting the solenoids to the controller:

Pass the solenoid wires through the large cables connector, and connect them to the connectio strips located at the bottom of the bottom panel.

B- black wire

R- red wire

W - white wire.

VM - main valve.

V1 - valve 1, etc.

Four W connections are possible.

W connections on the bottom connection strip are designated for valves 1 to 6 and for the master valve.

The W1 connections on the top connection strip are designated for valves 7 to 12.

The sensor wires must be connected to the SNS sensor connectors.

6. Close the panel by locking the screws on the controller's left side.

The controller is now ready to be programmed

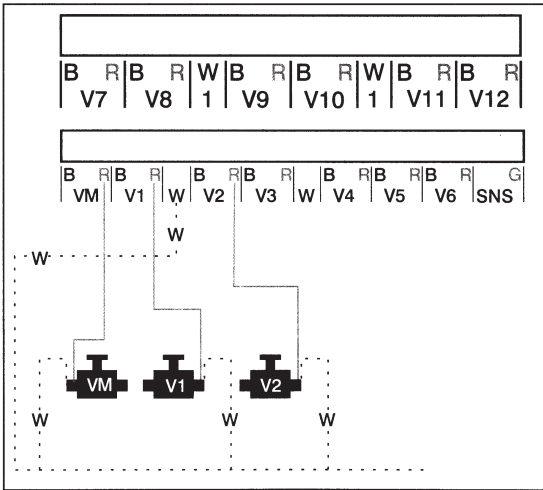

3. Programming the Irrigation Controller

This section describes the programming steps for a simple irrigation schedule. It is followed by a section dealing with more advanced irrigation controller operations.

- ⓐ The irrigation controller is programmed with the aid of 4 buttons: Programming Step Selector - used to select the desired programming mode (e.g., clock setting mode)
- ⓑ Parameter Selection Button - used to select the parameter to be changed (e.g., hour, minute, etc.). The selected parameter can only be changed when its entry is blinking on the display.
- ⓐ Increment Button - increases the value of the selected parameter (e.g., when hours is selected, from 06:00 to 07:00).
- ⓑ Decrement Button - decreases the value of the selected parameter (e.g., when hours is selected, from 06:00 to 05:00).

3.1 Setting the Current Time and Day of the Week

To enable the irrigation controller to operate the irrigation system at the correct times, the current time and current day of the week must first be set.



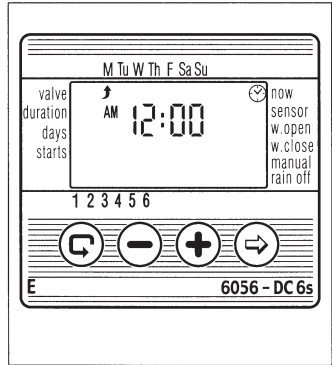

1. Press ⓐ several times until the ⓑ appears.
2. Press ⓑ The hour digits blink. Set the current hour using ⓐ and ⓑ (Note the AM and PM designations).
3. Press ⓑ The minute digits blink. Set the current minute using ⓐ and ⓑ.
4. Press ⓑ A blinking up arrow appears at the top of the display. Move the arrow to the current day of the week using the ⓐ or ⓑ button.



If the most recent data item stops blinking before you finish programming it, press ⓑ to continue the programming process.

3.2 Switching between AM/PM and 24 Hour Time Format

The default time format is AM/PM. There is also a 24 hour time format. To switch between the two formats:

1. Press  until the  appears.
2. Press  The hours digits blink.
3. Press  and  simultaneously. The clock reading switches from AM/PM to a 24 hour time display or vice versa.



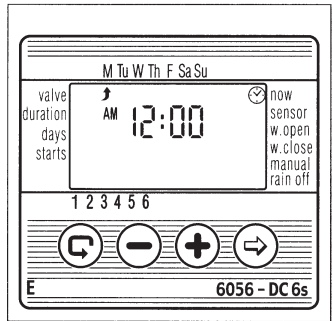



You can switch the time display format at any step in the programming process.



3.3 Valve Selection

This section does not apply to the DC-1 model.





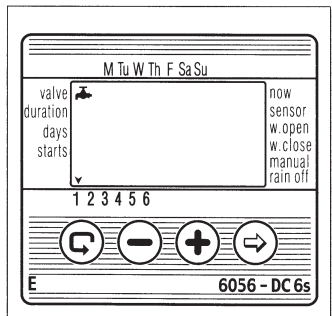



Program an irrigation schedule for each valve individually. First select the desired valve, and then program a schedule as follows:

1. Press  until  appears.
2. Press . A blinking arrow appears at the bottom of the display.
3. Move the arrow to the desired valve number by pressing  and .
4. Press  to proceed to the next step.



3.4 Setting the Irrigation Duration

This setting determines how long the irrigation lasts.



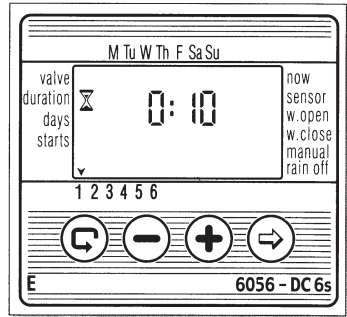



1. Press  until  appears.
2. Press . The hour digits blink. Set the desired number of hours by pressing  and . Press  again - the minute digits blink. Set the desired number of minutes by pressing  and .
3. Press  to proceed to the next step.
4. In professional controllers -"S" series, the duration of the irrigation can also be programmed in seconds.







The method of programming is the same.

3.5 Selecting Days of the Week for Irrigation

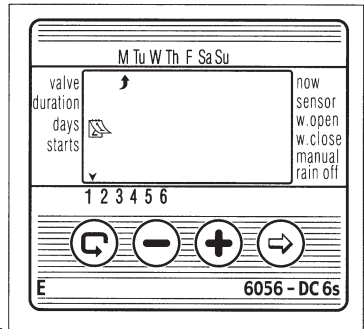
This setting determines which days of the week the irrigation controller will operate the specified valve.

1. Press  until  appears.
2. Press . A blinking arrow appears at the top of the display, under Monday.
3. Move the blinking arrow to the desired day of the week by pressing .
4. Selecting/adding irrigation days:
Press . The arrow under the selected day stops blinking, moves one position to the right, and blinks under the next day of the week. You can select additional days of the week in the same manner.
5. Canceling Scheduled Irrigation Days:
Have the arrow blink under the day you want to cancel. Press . The arrow under the selected day will disappear. The blinking arrow will move one position to the right, under the next day of the week. Cancel additional scheduled irrigation days in the same manner.
6. Press  to proceed to the next step.



• When the blinking arrow reaches Sunday, pressing  again displays  in the center of the display, and  at the top right of the display. To return to the "Selecting/Adding Irrigation Days" mode, press  once or twice.

3.6 Setting Irrigation Start Times

In this step, up to 4 separate irrigation start times can be programmed for a selected day for the valve being programmed. The selected valve will open at each of the start times set, for the irrigation duration set as described in Section 3.4.

1. Press \odot until the START I appears.
The word or the last start time set will appear on the display.
2. Press \leftarrow . The displayed item blinks (OFF or last start time entered).
3. Set the desired start time by pressing \oplus and \ominus . (Take note of the AM and PM designations). Repeat actions 2 and 3 to set start times II, III and IV, as needed.
4. To cancel a specific start time, select it by pressing \odot . Next, press \leftarrow . The hour digits blink. Press \oplus or \ominus until the word OFF appears on the display.
5. To program another valve, select it, and repeat the above steps, starting from section 3.3 above.

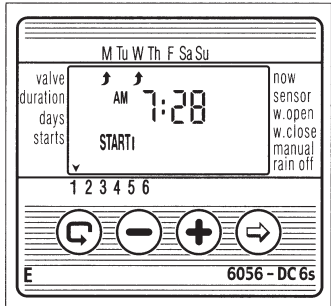





























3.7 Example: Programming a Weekly Irrigation Schedule

Let's assume you want to program the irrigation controller to water three times a day using the 24 hour time display format: at 08:00 AM, 13:00 PM and 19:00 PM, for 2 1/2 hours at a time, on Tuesday and Friday.

To switch to an AM/PM time display format, see section 3.2.

(If you are using a DC-1 model irrigation controller, start from step 4.)





1. Press  until  appears.
2. Press . A blinking arrow appears at the bottom of the display.
3. Press  or  to move the arrow to the number of valve to be programmed.
4. Press  until  appears.
5. Press . The hour digits blink. Press  or  until the hour displays 2.
2. Press . The minute digits blink. Press  or  until the minute displays 30.
6. Press .  appears.
7. Press . A blinking  appears at the top of the display, under Monday. Press  until the blinking arrow appears under Tuesday, and then press . The arrow under Tuesday will stop blinking and advance one position to the right, to Wednesday. Press  twice to move the arrow to Friday, and then press .
8. Press . START I time appears. Press . The hour digits blink.
9. Set the start time to 08:00 by pressing  or . Repeat this step to set START II time [2] to 13:00 and START III time [3] to 19:00.
10. Press . START IV time [4] appears. Press . The hour digits blink.
11. Press  or  until OFF appears. The fourth opening of the valve is canceled.

4. Additional Functions

4.1 One-Time Irrigation

This function is used to program the irrigation controller to operate the irrigation system once only, for the set irrigation duration, at the set time.

(Duration set as described in Section 3.4).



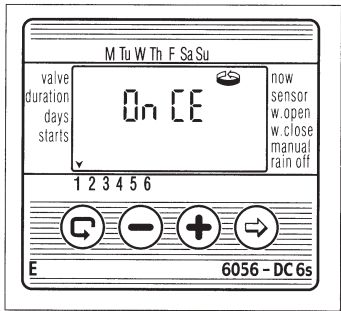



1. Press  until  appears.
2. Press  several times (for all the days of the week) until  appears, and  blinks on the display.
3. Go to Section 4.3 to set the start day and time.



4.2 Cyclical Irrigation

This option is used to program the irrigation controller to operate the irrigation system in a cyclical manner, once every x days, for the irrigation duration.

(Note: Duration for which valve stays open set as described in Section 3.4).

1. Press  until  appears.
2. Press  several times (for all the days of the week) until  appears, and  blinks on the display.
3. With the display blinking, press  or . The interval between irrigation sessions (irrigation cycle) in days, hours or minutes is displayed. For example, if you set 2 days, the irrigation will be performed every two days for the defined duration.
4. In the "S" series of professional controllers, the irrigation cycle can be programmed from one minute up. The settings are performed in the same manner.

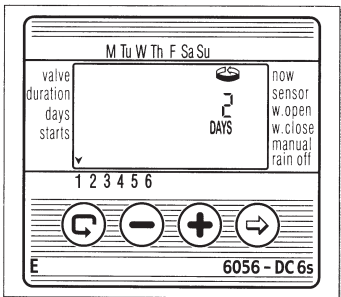





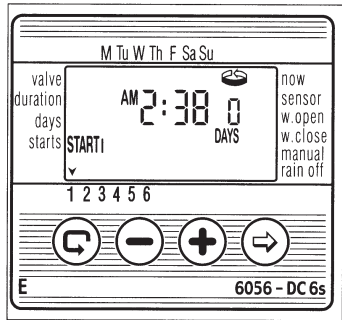

4.3 Setting the Day of the Week and Time

for Cyclical and One-Time Irrigation Programs

These programs enable you to pre-set the time of valve opening. The number of days until the valve opening appears on the display, to the right of the irrigation start time (above the word "days"). 0 days = program starts today; 1 day = program starts tomorrow, etc. (up to 30 days).











1. Press  until START [|] appears. The last opening time entered appears on the display.
 2. Press . The hour digits blink.
 3. Set the desired opening time by pressing  or  (Take note of AM and PM designations).
 4. Press  until the digit to the right of the opening time blinks (The digit above the word "days").
 5. Set the number of days until the opening of the valve by pressing  or .
- Valve openings 2, 3 and 4 are canceled in this mode.

4.4 Irrigation Window In the Cyclical Program Mode





The irrigation window function is incorporated in the "S" series of professional controllers. The irrigation window is an advanced feature which enables you to define that the operations in a cyclical irrigation program (see Section 4.2) be performed during a specified part of the day only (window). An irrigation window can only be defined for an irrigation cycle that is shorter than a full day (up to 23.59 hours), and only in the cyclical irrigation mode. If the irrigation cycle exceeds 24 hours, the window function is disabled.

This function is useful, for example, when irrigation is only required during the hot hours of the day.

1. Press  until  appears on the display next to W. OPEN. The word OFF or the last OPEN WINDOW time setting entered is displayed.
2. Press . The word OFF blinks on the display.
3. Press  and  to set the desired OPEN WINDOW time (pay attention to the AM/PM designation).
4. Press  until  appears, with 12:00 PM or the last CLOSE WINDOW time setting displayed.
5. Press  and  to set the desired CLOSE WINDOW time (pay attention to the AM/ PM designation).

*If an irrigation cycle exceeding 24 hours has been programmed, the irrigation window function is disabled.

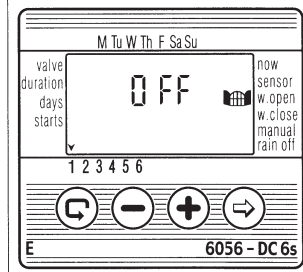
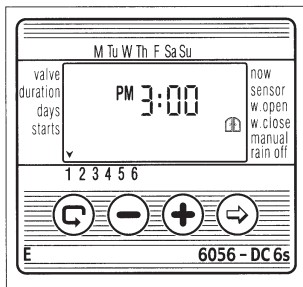
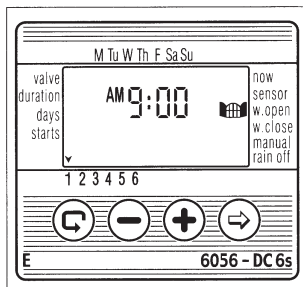

To cancel the irrigation window

1. Press  until  appears next to OPEN WINDOW, along with the display of the last OPEN WINDOW time setting entered.
2. Press . The irrigation window open time blinks on the display.
3. Press  until Off appears next to . The irrigation window is now cancelled.















4.5 Opening an Irrigation Window after Start Time has passed

Example: You are setting an irrigation program specifying 5 minutes of irrigation every 30 minutes, from 9:00 AM to 5:00 PM. However, you have entered the settings at 9:20 AM. As a result, the program will not commence today, but only from 9:00 AM tomorrow. To force the program to begin today, perform the following steps:

1. Press  until START I is displayed.
2. Press  and  to set any time after the current time: e.g. 9:30 AM. This time will constitute the first start time for today. From tomorrow, the schedule will operate according to the program you set. The Start I display will display the next start time taking into account the window you have set.

4.6 Example: Programming a Cyclical Irrigation Schedule



Let's assume you want to program the irrigation controller to open the valve at 12:45 PM, for a period of one hour, every 5 days.

1. Set the irrigation duration as described in Section 3.4: Setting the Irrigation Duration. (Press  until  appears, then set the desired irrigation duration by pressing  and ).
2. Press  until  appears.
3. Press  a number of times (for all the days of the week) until OnCE appears blinking on the display.
4. While the display is still blinking, press  or  until "5 days" appears on the display, representing the irrigation frequency.
5. Press . START I is displayed.
6. Press . The hours digits blink.
7. Press  until the hours digits change to 12 (PM).
8. Press  until the minute digits change to 45.

4.7 "Manual" Irrigation System Operation via the Irrigation Controller



This function operates the selected valve for the irrigation duration defined in the program. The valve will close automatically at the end of the irrigation duration.

Note that the originally programmed irrigation schedule continues to operate at the set times.

1. Press  until  appears. Select one or more valves as described in Section 3.3: "Valve Selection".

2. Press  until  appears.

3. Press  to open the valve. The word "On" is displayed. After an interval of 5 seconds, a count down of the remaining irrigation duration appears on the display.

To close the valve manually, press .  appears on the display.

4. To close the valve manually before the end of the irrigation duration, press  until ON appears again on the display.

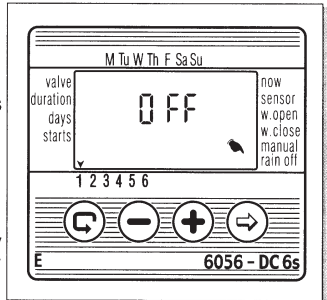
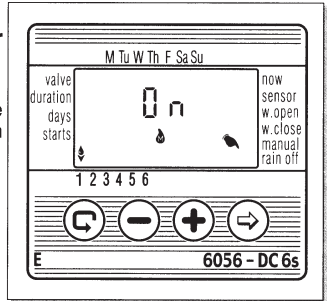

Press  to close the valve.

Up to two valves can be operated simultaneously in this manner. Simply repeat the above steps for the second valve.



4.8 Sequential "Manual" Operation of all the Valves

The valves can be operated sequentially, one after the other.

1. Press  until the  appears.

2. When nothing is blinking on the display, press and hold down  for 5 seconds. Valve 1 will open and operate for the programmed irrigation duration. When valve 1 closes, valve 2 opens, and so forth until the last valve has opened. All the valves designated to open blink.





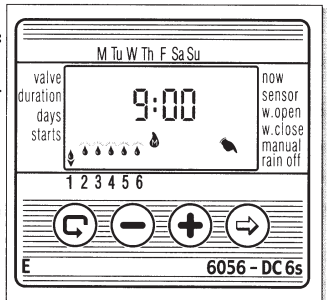



3. You can influence the process. Pressing  closes the current valve and opens the next one.

4. Important: You can only exit this screen after all the valves have opened.



4.9 Suspension

This option is used to temporarily suspend the irrigation controller's control of the valves, for example, while it is raining. The irrigation schedule remains stored in the controller, but is not implemented. The suspension option disables ALL valves connected to the irrigation controller.



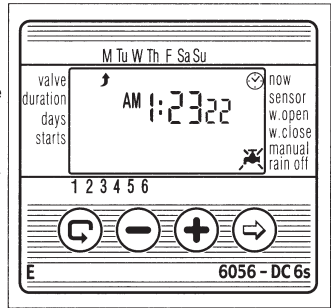





1. Press  until the  appears.
2. Press and hold down  for 5 seconds.  appears blinking alongside the word "rain off". The controller is now suspended.
3. To restore control to the controller, press  until the  appears, and then press  and hold down  until the  disappears.
4. Suspension can also be implemented while a valve has been activated.
5. If an attempt is made to operate a valve manually while the irrigation controller has been suspended, or when a valve is meant to open sequentially, the word "rAin" appears on the display, and the valve will not open.



4.10 Irrigation Duration Extended or Shortened by a Specified Percentage

You can extend / shorten the irrigation duration for all the valves simultaneously by specifying a percentage for the duration.

Example: if the irrigation duration has been set to one hour, adding 10% extends the duration by 6 minutes (to 66 minutes).

1. Press  until the  appears.
2. Wait until no digit is blinking
3. Press  and  simultaneously. 00+% is displayed.
4. Press . The 00 blinks. Press  or  to increase or decrease the percentage as necessary (in increments of 5%). +% or -% is permanently displayed on the main  display, accordingly.

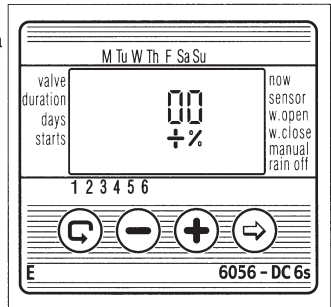

Important! The percentage cannot be changed for an individual valve.

5. Additional Displays

5.1 Valve in Wait Mode

This section does not apply to the DC-1 Model.

When two valves are currently open, and a third valve is scheduled to open, the third valve enters into wait mode. A blinking **W** appears above the number of the waiting valve. When one of the first two valves closes, the waiting valve opens. During "manual" operation of a waiting valve via the irrigation controller, the letter **W** (Wait) appears on the display. The valve opens when another valve closes.

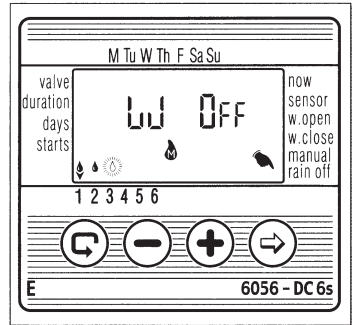

5.2 Blinking Low Battery Warning

When the batteries are low, a blinking battery icon appears on the display. In this state, the batteries still enable valve operation, but must be promptly replaced.

After replacing the batteries, press any button to resume irrigation controller operation. Programmed data are retained if batteries are replaced within 30 seconds.

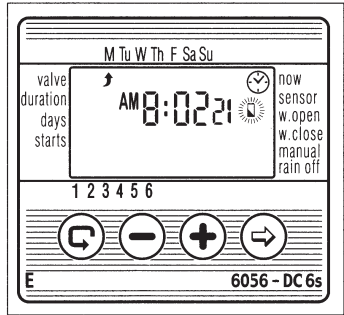

5.3 Permanent Low Battery Warning

When the batteries are low and not replaced in a timely manner, the battery icon is permanently displayed. All other display elements disappear and all valves are closed.

Replace batteries promptly, and press any button to resume irrigation controller operation.

Programmed data are retained if batteries are replaced within 30 seconds.

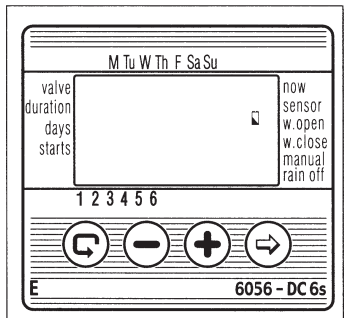

5.4 Missing Program Data

During "manual" irrigation system operation via the irrigation controller appears on the display (see Section 4.7: "Manual Irrigation System Operation"), indicating that no irrigation duration has been set for the specified valve. In this case, opening of the valve is disabled.

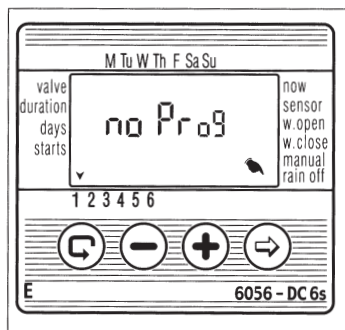

5.5 Sensor

Available in professional ("S" series) controllers.

The irrigation controller offers advanced irrigation control using a lockout sensor. That is, as long as the conditions defined for activation of the sensor are not met, the irrigation schedule will not be implemented. (The lockout sensor contact remains closed). Any valve connected to the controller can be operated in conjunction with the sensor. To associate a sensor with a particular valve(s), select the desired valve(s) and activate the sensor for them (see the explanation below).

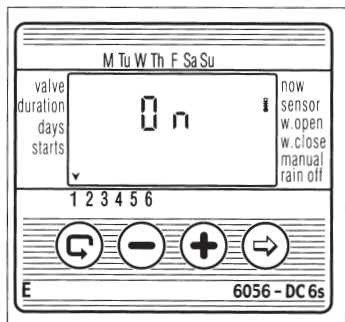

For example, if a rain sensor is connected to the irrigation controller, irrigation takes place as long as the sensor remains dry. In the event of rainfall, the sensor prevents the opening of all the valves associated with it.

1. Select the valve to which you want to associate the sensor.
2. Press \odot until  appears alongside the label SENSOR.
3. Press \oplus to activate the sensor in the irrigation program for the selected valve. The word On is displayed.

As long as the sensor closes the circuit (i.e., the sensor detects the existence of a defined program lockout condition) the symbol  blinks on the display and irrigation will not take place through any valves associated with the sensor.

Press \ominus to disable the sensor. The word "OFF" appears on the display.

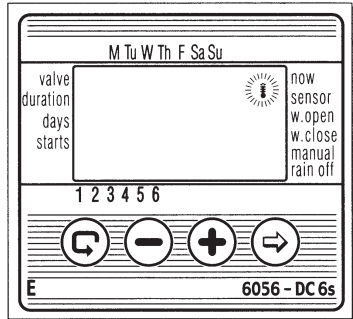

6. Maintenance, Troubleshooting and Repairs

- Batteries should be removed if the irrigation controller is not going to be used for a lengthy period.
- A filter must be installed upstream of the valve or system of valves and cleaned every few months. Operation without a filter is liable to lead to malfunctions.
- Under normal usage, batteries (Alkaline) last at least a year.
- Do not run water through an irrigation line unless a solenoid is fitted on the hydraulic valve.
- Recommended water pressure: 1-8 ATM (bar).

Problem/Event	Cause	Solution
Valve does not open during Automatic operation or during "Manual" operation via irrigation controller	Valve handle not in AUTO position.	Move valve handle to AUTO position.
	Batteries not working	Replace batteries
No display	Batteries not working	Replace batteries
Valve does not close, despite click heard during activation	Valve handle not in AUTO position.	Move valve handle to AUTO position
	Dirt and scale in valve mechanism	Clean or replace valve
	5 mm seal (O-Ring) between bayonet adapter and valve missing (See illustration below)	Install new seal (O-Ring)
Water leak from the solenoid-valve coupling connection	20 mm seal (O-Ring) between bayonet adapter and valve missing (See illustration below)	Install a new seal (O-Ring)

1. 20 mm seal (O-Ring).
2. 5 mm seal (O-Ring).

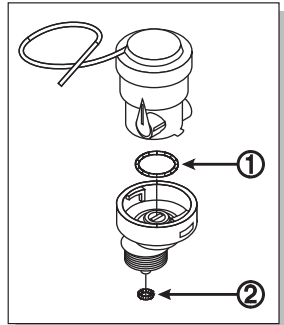

7. Additional Accessories and Products

7.1 General

Lockable protective box
Line Filter, BSP 3/4"
Line Filter, BSP 1"
Waterproof connector
Extension cable for solenoid cables

7.2 Two-way (2W) Controllers

Spare Parts Kit: bayonet adapter, plunger and O-rings

Valve + DC solenoid from Galcon:

2W 3/4(valve + solenoid

2W 1(valve + solenoid

2W 11/2(valve + solenoid

2W 2(valve + solenoid

2W DC Solenoid Only:

3/4(Valve + 2W bayonet adapter

1(Valve + 2W bayonet adapter

11/2(Valve + 2W bayonet adapter

2(Valve + 2W bayonet adapter

7.3 Three-way (3W) Controllers

Three way controllers DC-1S and DC-4S are available (for hydraulic control)

3W controller accessories:

1/8 valve + solenoid

1/8 base

3W solenoid

Auxiliary Table for Irrigation Planning with Galcon Controllers



Date: _____

Valve No.	The irrigation/vegetation area (window box, porch balcony, lawn)	Irrigation Program		Irrigation Duration (minutes, hours)	Daily start times			
		Weekly	Cyclical		1	2	3	4
1		M, Tu, W, Th, F, Sa, Su						
2		M, Tu, W, Th, F, Sa, Su						
3		M, Tu, W, Th, F, Sa, Su						
4		M, Tu, W, Th, F, Sa, Su						
5		M, Tu, W, Th, F, Sa, Su						
6		M, Tu, W, Th, F, Sa, Su						



Israel's Leading Manufacturers of Irrigation Controllers

Kfar-Blum 12150, Tel. 972-4-690-0222, Fax. 972-4-690-2727

E-Mail: info@galcon.co.il, www.galcon.co.il

Cat. No. **E-B** 432.04