

FILTRATION MODULE

SECTION 1

FILTRATION – PRINCIPLES AND DESIGN

Table of Contents

Table of Contents.....	2
1 Introduction	3
2 Objectives	3
3 Reasons for Filtration	4
4 Definitions and Materials	4
4.1 Definitions.....	4
4.2 Materials	6
5 Water Sources and Quality	7
5.1 Nature of contaminants	7
5.2 Water sources	8
5.3 Clogging Factors	9
6 The Filtration Process	10
7 Brief Overview of types of filters and their applications	10
7.1 Depth or Volume style filters.....	11
Gravel filters.....	11
Disc filters	12
7.2 Surface Filters	13
Screen filters	13
7.3 Hydro cyclones.....	15
8 Selection and Design principles	16
8.1 General.....	16
8.2 Check filters.....	16
8.3 Manual or Automatic?.....	17
8.4 Pre-filtration	17
8.5 What mesh rating to select?	18
9 Installation and Maintenance.....	20
9.1 Installation	20
9.2 Maintenance.....	20
10 Summary and Conclusion	21
11 Questions.....	22
11.1 Beginner.....	22
11.2 Intermediate	23
11.3 Advanced.....	24

1 Introduction

In agriculture and industry there is a requirement to filter water to avoid blockages of emitters which would result in system inefficiencies. It is necessary to consider the various water sources and the changes that occur within the sources over time in order to select a filtration system that suits the irrigation system, operator and budget.

This unit has been developed to cover the common types of filtration systems in use and the situations in which each would be applied. The unit briefly looks at the advantages and disadvantages of each method and serves to provide a platform for the reader before commencing the more detailed sections of the "Filtration" module on

- ◆ Disc Filters
- ◆ Screen Filters
- ◆ Hydrocyclones & Sand separators
- ◆ Gravel Filters
- ◆ Filters – Industrial and Multimedia

2 Objectives

The objectives of this section are

- ◆ Summarize the different water sources and filtration systems commonly used
- ◆ To provide a working knowledge of definitions, materials and jargon associated with Agricultural filtration
- ◆ To present a brief overview on the types of filter applications
- ◆ To ensure a good understanding of the above subjects
- ◆ Mention other related subjects which will be covered in more detail in later sections

3 Reasons for Filtration

The major purpose of filtration in Agricultural irrigation is to remove suspended material from the water source. The suspended material only includes particles usually larger than 0.45 micron. We do not have to remove all such tiny particles for our micro irrigation systems but if the particles that affect us are not filtered then the resulting problems that occur are

- ◆ Scouring and wearing of nozzles by sand, leading to inefficiencies and excessive emitter flows
- ◆ Blockage or clogging of both drip and sprinkler emitters, usually by organic material, but also by inorganic material
- ◆ Malfunction of valves and associated equipment that are hydraulically activated

In any above event the irrigation system's integrity is endangered and this could result in water, energy and fertiliser wastage plus loss of crop all of which cost money. The net result can be minor losses to a major catastrophe.

4 Definitions and Materials

4.1 Definitions

Total Suspended Solids (TSS) A term which expresses the mass, in mg/L, of particles, larger than 0.45 micron, in the water.

Turbidity A term which expresses the clarity of the water. The measurement is based on determination of light transmission through the water, in units of NTU. This does not usually affect our requirements for Agricultural micro irrigation.

Particle size distribution A measurement of the size of the particles in the water and the relevant proportion of the particle populations according to their size. This parameter is usually confined to Industrial applications.

Mesh size the degree of filtration is usually expressed in mesh size, which relates to the number of openings per inch. The higher the Mesh number the smaller the particle that should be trapped or filtered out.

Micron (μ) unit of measurement for particle sizes. 1000 micron = 1 mm.

General filtering area the area consists of the length multiplied by the circumference of the filter element. The active filtering area is the total area of perforations and the inactive area comprises the filter elements reinforced parts.

Filtering ratio this is the relationship between the cross section area of the filter and the active filtering area. If a 10" (250mm) filter has a cross section area of 500cm² and the active filtering area is 4500cm² - the filtering ratio is 1:9. The minimum should be 1:8, and anything higher is a positive feature

Flow capacity the flow capacity of a filter depends on its diameter, the filtering system and water quality. Although diameter is a decisive factor for flow, its effect may be offset by the filtering system. For example a 2" disc filter may have a higher flow capacity than a 16" gravel filter. Manual filters have lower flow capacities than automatic units.

Flow Velocity this is determined by the flow rate and the diameter of the filter. High flow velocity may cause frequent clogging of the filter. A 2" screen filter with a diameter of 200mm may cope with a 20m³/hr flow at 18 cm/sec velocity while a gravel filter with a 500mm diameter filters a 12 m³/hr flow at a velocity of only 1.7 cm/sec. High velocities may cause filter elements to collapse during filtration or gravel media to be lost during the back wash process.

Head loss usually split into two categories which are

- ◆ Loss at maximum flow when the filter is in a clean state. A 2m to 3m head loss in this state is considered acceptable.
- ◆ Pressure Differential Loss at maximum flow when the filter is "dirty". Also known as "PD" or "DP" (Delta P). A 5m to 7m PD is considered normal before cleaning or back washing is necessary.

Flushing frequency is determined by the allowed pressure differential (PD) between the filter inlet (upstream side) and filter outlet (downstream side), taking into account also the time factor. Flushing too frequently can be wasteful and can disrupt the irrigation regime. Flushing frequency can be reduced by

- ◆ Over design of the filter
- ◆ Using a lower (but suitable!) mesh grade
- ◆ Pre-filtering (sedimentation, appropriate suction placement etc)

Filter cake – a build up of material on the filter element (screen or disc) or on the top of the gravel bed in a media/sand filter

Channeling/Tunneling a phenomenon in gravel filters where "streams" of unfiltered water create channels or tunnels through the media bed from top to bottom and work their way through the mushroom diffusers with suspended material. It can be the result of too high a flow velocity and is worsened by ineffective back washing.

4.2 Materials

Many different materials are used in the construction of filters used today. It would be fair to say that with the advancement of plastic technology a high proportion of filters are made of plastic materials. Traditionally filters were made of metal but the corrosive nature of some types of water led to a breakdown of filter bodies and inserts. Advantages of plastic units are

- ◆ that they can be more economical to purchase and maintain
- ◆ their light weight makes them friendlier and easier to transport and install
- ◆ Normal agricultural water does not corrode them

Filter bodies can be constructed of mild and carbon steel (usually coated with epoxy or polyester), Stainless steel of various grades from the cheaper SS304 to the more expensive SS316. Plastic bodies are made of Polyester, reinforced polyamide, reinforced polyester and polyethylene.

“O” Rings are usually of nitrilic rubber

Springs that are inside the filter are made of Stainless steel

Disc elements in Grooved disc style filters are of polypropylene with the spines of acetal and thermosetic polyester

Screen elements are made of plastic, woven, wedge or perforated stainless steel, PVC.

Valves are usually metallic made of bronze, but plastic is becoming more widely accepted and used.

Usually the manufacturer's specifications will detail the materials used in the construction.

5 Water Sources and Quality

5.1 Nature of contaminants

Water quality is normally directly related to its source. Across the world, water quality is becoming an issue. The end result for irrigators is having to deal with not only reductions in water availability but also with water of a lower quality.

The particles which clog systems may be broken into two categories

- ◆ Solid mineral materials (inorganic) and
- ◆ Large micro-organisms (organic).

Solid Mineral Materials

Soil washed into watercourses is the principle source of solid mineral materials in water pumped from rivers, lakes and dams. Erosion and neglect of upstream catchments has made this an increasing problem. A badly placed pump can exacerbate the problem by picking up material from the bottom of a dam. The particles from these sources are generally silt, and range from 10 to 80 microns in size.

Where water is drawn from an underground bore, larger particles of coarse and fine sand may be picked up. This type of particles range in size from 100 to 1000 microns.

Large Micro Organisms

Where water is exposed to air and light, zooplankton and algae will grow. Zooplankton in particular may grow to sizes of 100 to 300 microns.

Inside pipes and drip tubes, conditions can be ripe for the growth of single cell micro organisms. If the water contains sufficient oxygen and dissolved nutrients, single cell micro organisms may flourish in areas which are well after the primary filtration. If left unchecked, they will clog emitters and restrict flow through pipes. They must be removed by chemical and biological treatment: eg. Chlorination.

5.2 Water sources

Municipal Water usually the highest quality of water used for agricultural irrigation and also the least used because of price; however it is widely used in commercial and domestic landscape irrigation. This water is generally treated to “potable” quality and therefore contains insignificant amounts of organic matter and has a low occurrence of suspended solids and chemicals.

Boreholes and Wells again have a low concentration of organic matter, but can have a high probability of sand occurrence. High concentrations of iron, manganese, hydrogen sulphide, sulphates and carbonates are not uncommon.

Reservoirs often contain organic matter such as algae and crustaceans of various sizes, plus inorganic matter such as silt and clay flocculates in suspension.

Canals and Ditches have algae, larvae and eggs plus bacterial slime (which acts as a binding agent). Also varying quantities of sand, silt and clay.

Treated sewage also known as recycled waste water is loaded heavily with nutrients especially nitrogen, and can have Total suspended solids (TSS) of 250 ppm, depending on the level of treatment.

It should be noted that changes occur to the quality of the particular water source over time and the following should be considered.

- ◆ Daily changes can occur in reservoirs and lakes/dams exposed to winds of varying velocities and directions.
- ◆ Monthly changes take place in reservoirs as the sediment load increases with the gradual drop in water level.
- ◆ Annual changes are caused by droughts, increasing the concentration of impurities.

More detail can be found in the Sections under the “Water – Sources and Quality” Module.

5.3 Clogging Factors

Clogging factors are documented under three categories

- ◆ Inorganic suspended solids
- ◆ Organic (biological) matter such as bacteria and algae
- ◆ Sediments generated by chemical reactions

With particular reference to “Trickle” or Drip irrigation systems the clogging hazard has been quantified by Bucks and Nakayama 1980. Refer to Table 1 below

Table 1 Potential risk of Blockage in Drip Irrigation systems

Water quality	Indicators	Potential Risk		
		Little	Slight to Moderate	Severe
Physical	Suspended solids (mg/L)	< 50	50 – 100	> 100
Chemical	pH	< 7.0	7.0 – 8.0	> 8.0
	TDS (mg/L)	< 500	500 – 2000	> 2000
	Manganese (mg/L)	< 0.1	0.1 – 1.5	> 1.5
	Iron (mg/L)	< 0.1	0.1 – 1.5	> 1.5
	Hydrogen Sulphide (mg/L)	< 0.5	0.5 – 2.0	> 2.0
Biological	Bacteria (No/100mL)	< 1 x 10 ⁷	1 – 5 x 10 ⁷	> 5 x 10 ⁷

(after Bucks and Nakayama 1980)

Also mentioned up to now was the problem with sand in irrigation systems. To understand better what we are dealing with refer to Table 2 below

Table 2 Particle size in relation to Mesh equivalent and Micron (μ)

Material	Size in Microns (μ)	Mesh equivalent
Very coarse sand	1000 – 2000	10 – 18
Coarse sand	500 – 1000	18 – 35
Medium sand	250 – 500	35 – 60
Fine sand	100 – 250	60 – 160
Very fine sand	50 – 100	160 – 270
Silt	2 – 50	
Clay	< 2	

Note how very fine Clay particles are. They cannot be filtered out by normal agricultural filters – despite how many times the grower may ask!

6 The Filtration Process

Filtration can be defined as the separation of a suspension into its components – solid and liquid. Water contains suspended particles of different sizes and shapes, both organic and inorganic, most of which are not symmetrical. The particles will usually be elongated or a pronged “D” shape. The separation process begins with identifying the particular properties of the materials to be separated and the differences between those properties such as density and particle size. Also consider magnetic, chemical and electric characteristics.

Because of the changing shape and consistency of the particles, the filtration process is a statistical process. Therefore a statistical process requires enough recurrences in order to provide an accurate result of high efficiency.

The filtration process begins before we reach the filter itself! We need to pay attention to placement of the suction basket/foot valve and if need be incorporate stone and frog traps in our pump suction line. Automatic suction strainers can be useful too.

With micro irrigation systems the unfiltered water is passed through a porous medium (screen, disc or crushed basalt) where the solid particles are retained. This is a physical rather than a chemical process.

If sand is present in the unfiltered water (at levels exceeding 50 ppm) it is necessary to separate the sand from the water before passing through the main filter. This is accomplished by utilising centrifugal forces to drop the sand out – the sand has a specific gravity of about 1.5 whilst water is 1.0 (1.0 kg/L).

A filter’s performance is judged by its ability to remove particles of a certain spectrum thereby protecting the emitters in the system *and* its ease and efficacy of back washing, especially if it is an automatic unit. Details of the filtration process for different types of filters will be covered in the later Sections of this “Filtration” Module.

7 Brief Overview of types of filters and their applications

For our purposes ie. Agricultural micro irrigation, we have 3 categories of filters

- ◆ Depth or Volume style
This includes Gravel (sand or media) filters and Grooved discs. They are referred to as such because the debris and dirt is retained across the width and length and within the *depth* of the filter. For agriculture where the sources of open water are usually laden with organic matter, Depth or Volume style filters should be considered as the first choice.
- ◆ Surface style
We refer here to screen filters that simply have an element with length and a breadth to constitute a “surface area” of filter to trap the solids. They can only retain a lesser amount of dirt before a back wash is required, compared with Depth or Volume style filters. Surface style filters have their limitations – “screen filters do not work well at removing organic matter” – acknowledgement to RainBird® Low Volume Irrigation system Maintenance Manual 5/90.
- ◆ Hydrocyclone style
These have no innards and rely on a pressure differential being created to force the sand particles outward and downward whilst the rest of the suspension moves upward to the main filter.

We will have a brief look at these different types of filters

7.1 Depth or Volume style filters

Gravel filters

These are also known as sand or media filters. One of the earliest forms used in drip irrigation and still popular today. They are considered “top of the range” but carry the appropriate price tag. They tend to be first choice with difficult water and not surprisingly they perform well providing the selection, installation, operation and maintenance of the units is followed faithfully. Extensive trials have been conducted overseas in Israel and other countries where the findings point out they rank first in protecting emitters when using treated waste water. Refer to Figure 1 below

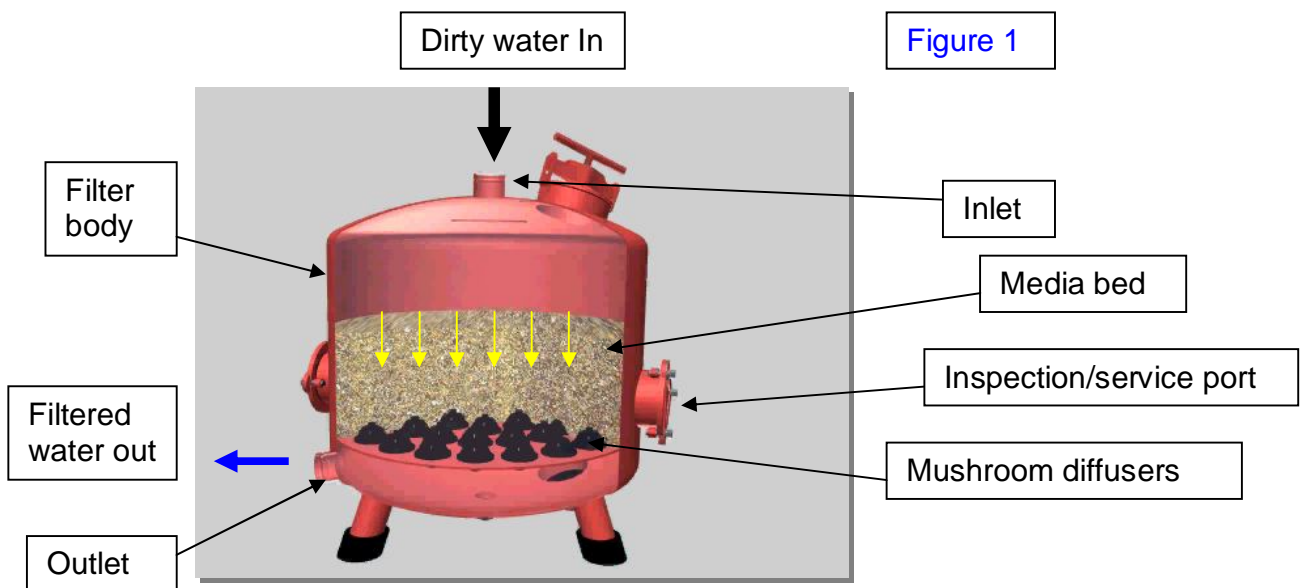

During the *filtration process* unfiltered water passes through the inlet via a bed of media (sand, silica, crushed basalt etc) and the dirt is trapped by the material. Most private homes with swimming pools have this type of filter – a sparkling pool is often testimony to the efficacy of the filter!

Separating the media bed from the filtered water is a series of “mushroom diffusers” – these mushrooms (so named because the shape resembles a mushroom!) are made of plastic and have fine slits, like a Johnson® bore screen. The slits are large enough to allow the filtered water to pass through with minimal head loss, but small enough to prevent the media from bypassing.

The *back wash cycle* involves reversing the direction of flow of the water, the water being provided by another filter or filters in the battery. It should be noted that this water is clean and filtered. The back wash flow is critical, as we need to “fluidise” the bed of media and lift off the accumulated dirt and debris. This control is achieved by limiting the flow with a throttling valve, usually manual. Once the dirt has been removed the flow can be reversed and filtration can recommence.

Disc filters

Disc filters employ what is known as “grooved disc technology”, which was allegedly developed by aircraft manufacturers in B52 bombers to provide a compact filter to protect the hydraulic oil circuits from contamination. Apparently this was extended to ships and submarines. The benefits of the grooved disc technology are

- ◆ High dirt retention capability – “volume style filtration”
- ◆ Tolerance to high PD and minimum risk of element collapse
- ◆ Accurate filtration
- ◆ Small footprint and lightweight construction
- ◆ Manual units easy to clean, automatic units have efficient cleaning process

Each ring (disc) is specially designed with grooved lines on both sides in an angled direction – see Figure 2 below. The groove width remains constant and the rib width decreases toward the centre, maintaining the true “mesh size”. This applies to Arkal products, but not necessarily others! When the rings are stacked upon one another, the grooves will overlap 10 to 30 times, depending on the mesh size. Particles are trapped at the outer rim of the discs’ many intersections. Being made of polypropylene they are resistant to chemicals or cleaning agents such as acids or chlorine.

Cross section of a “grooved” disc

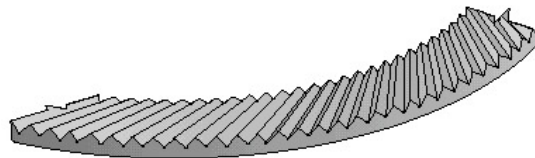

Figure 2

Filtration by disc filters is accomplished by the entry of dirty water from the outside of the disc stack, through the discs’ various intersections trapping the dirt. Back washing automatically entails the reversal of water flow, by changing the position of the back wash valve, and clean, filtered water from other filter/s in the battery will release the spine set and force water through jets in an outward direction. These jets are angled tangentially so that the discs, now riding on a cushion of clean water, and spun around vigorously thus releasing the entrapped dirt. The effect of the pressurised nozzles and terrific centrifugal action is highly effective in that only a short, sharp cleaning action is required. See Figures 3 and 4 below

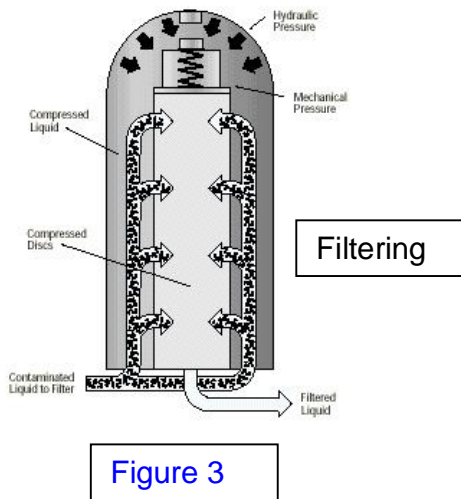

Figure 3

Backwashing

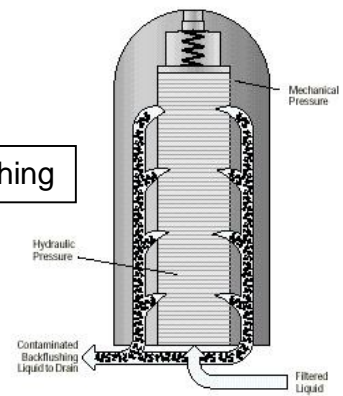

Figure 4

Back washing manually means closing the pressure off, opening the filter cover, removing the filter element and loosening the disc set. Usually a quick hosing with a nozzle is sufficient to remove loose dirt. More persistent material build up may require occasional chemical washing.

The disc filters come in various diameters, with manual models ranging from 20mm, 25mm, 40mm, 50mm, 80mm and 100mm. Automatic models range from 50mm up to 400mm, with a modular construction.

Disc filters can be used with confidence in most applications and are effective in separating algae from water. They are an economical option to Gravel filters in many instances, although should not be used in very bad water nor with water containing significant levels of iron.

7.2 Surface Filters

Screen filters

Screen filters were developed early on in the piece and are still widely used today. Improvements with design and materials has widened their use, although devotees of Depth and Volume style filters will argue the merits of Gravel and disc filters over screen. The perceived benefits of screen filters are

- ◆ Simple construction and easily understood
- ◆ One filter usually used instead of a battery in most cases
- ◆ Uses small amount of water to backwash, similar to disc filters.

A screen filter generally has one filtration point with passages of one size – the blockage force is a simple mechanical one and sometimes can be of an adhesive nature.

Screens are made of woven mesh, perforated plates or of a wedge style construction. See Figure 5 below

Figure 5

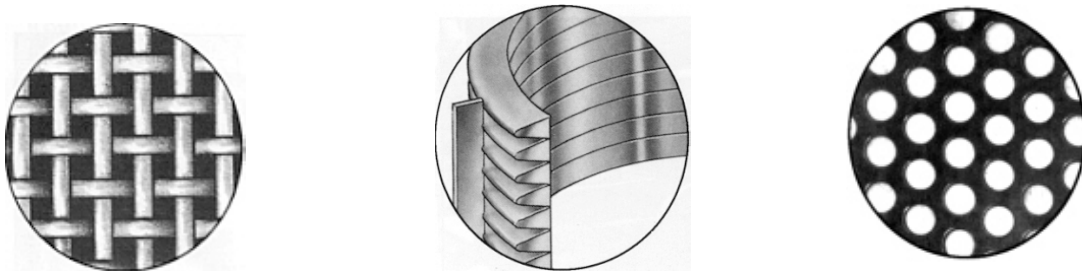

Different screen elements showing, from Left to Right, Woven screen, Wedge wire and Perforated plate

Screen filters can be built in almost any size and are commercially available in a wide range of flows. They are a single *surface* filter with only one retention point for solids. The range of mesh sizes is also wide, from 30 to 200 mesh. Whilst screen filters can be a main automatic unit they are widely used as secondary filters for gravel systems and check filters in the field. Refer Figure 6 below. Although the effective filtration area can be quite high and the initial “clean” head loss is quite low, the PD can build up quickly. Therefore an effective cleaning schedule is a necessity.

Screen filters can be cleaned manually or automatically, like all other types of filter. Manual cleaning usually involves removing the filter element and hosing/brushing it clean. Automatic units utilise a number of methods to clean themselves such as

Motorised brush a brush rotates over the screen element dislodging the “filter cake” and a purge valve will allow the dirt to exit to atmosphere, whilst the system is under pressure.

Through flushing a valve at the end of the filter barrel opens up and the accelerated flow washes the screen

Suction scanner a rotating suction scanner lifts “filter cake” off the screen without actually making physical contact – this system can be quite effective and does not damage the screen as a brush does.

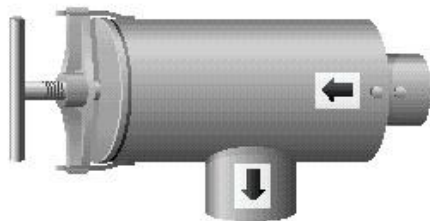

Odis 1900 series Manual screen filter.

Figure 6

- 1 Handle
- 2 Bridge
- 3 Cover
- 4 Cover gasket
- 5 Centering piece
- 6 Filter element
- 7 Inner gasket

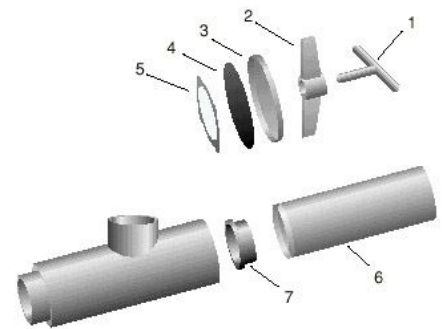

Some screen filters can be useful in handling *light* loads of sand, but are generally not favoured for high organic loads

7.3 Hydro cyclones

Often used as a “pre-filter” before main automatic (or manual) filters these devices can efficiently remove mineral particles larger than 100 μ . Hydro cyclones or “sand separators” are usually installed near wells, bores and water supplies that carry high loads of suspended sand. Refer Figures 7 and 8 below

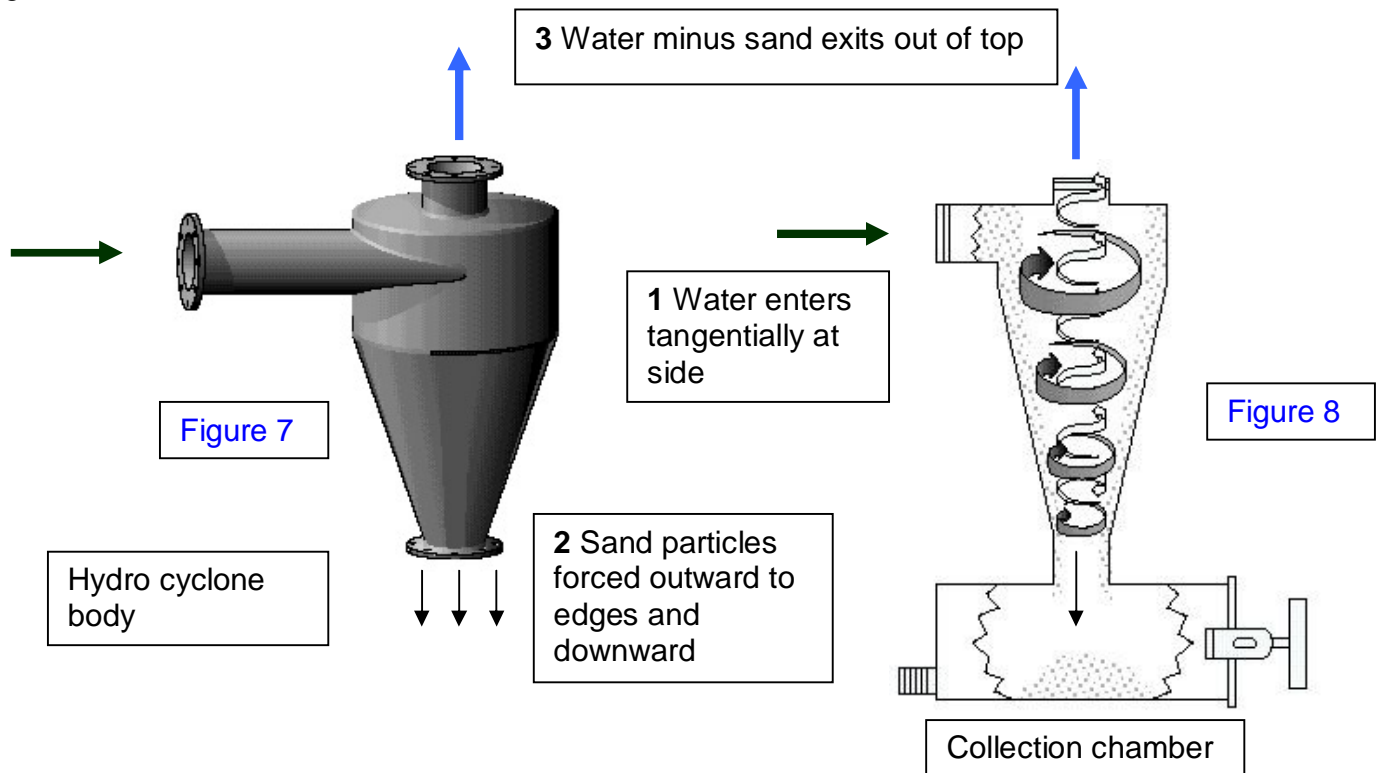

The solid particles need to have a specific gravity greater than water i.e. greater than 1. A head loss must be generated between the tangential entry port and vertical exit port which forces particles by a centrifugal or vortex action outwards and downwards. Sediments are collected in a chamber at the bottom of the separator and are purged periodically. The principle and mechanism is simple and effective with no moving parts, although “wear plates” need to be replaced from time to time.

Separation efficiency is determined by flow and head loss – generally speaking the higher the head loss and smaller the diameter of the separator the better the efficiency. The pressure drop is constant with a given flow as there is no filter element to “block up” – but remember to purge the collection chamber regularly.

NB Organic material will not be removed, and nor will clay or silt.

Hydro cyclones can also be used to mix air into water and to incorporate fertilisers or chemicals effectively.

8 Selection and Design principles

8.1 General

The contaminants which create clogging in an irrigation system will also cause problems for filters. The filtration system must be designed with the relevant flows and water qualities in mind. A filter system which is under specified will block quickly and require constant cleaning. A system which is heavily over specified will not only be excessively costly but may also under perform because the flow through the filter media is not sufficient to guarantee adequate back washing. The filtration system must be seen as a safeguard to protect the micro-irrigation equipment from clogging and to ensure that it continues to operate properly through its designed lifetime.

We must bear in mind what it is we are trying to protect and select the filter to suit. For instance drip irrigation requires a higher level of filtration than does impact sprinklers – Refer to the later “Gravel Filter” section in the “Filtration” module.

For a General Guide as to the selection of filters with respect to different water qualities and contaminants see Table 3 below. More specific Selection criteria will be covered in the later sections to follow. In the boxes under “Filter Type” will be a number, 1 being the #1 or first choice and 3 being the #3 or third choice.

Table 3

Contaminant	Quality	Measurement (ppm)	Filter type			
			Hydro cyclone	Gravel	Disc	Auto screen
Soil particles	Good	' 50	1	2		3
	Bad	< 50	1	2		3
Suspended solids	Good	' 50		1	2	3
	Bad	< 50		1	2	
Algae	Good			2	1	3
	Bad			1	2	3
Iron and Magnesium	Good	' 0.5		2	1	2
	Bad	< 0.5		1	2	3

8.2 Check filters

It is generally regarded as good practice to have “check filters” in the paddock, especially when there is

- ◆ a significant distance from the main filter to the block
- ◆ poor water quality

The additional cost of fitting these units is offset by the benefit of the added protection they offer. What can, and does, happen in practice are breaks in the mainline. This will mean intrusion of large quantities of dirt that will quickly enter the sub mains, laterals and emitters. This is a nightmare that every irrigator dreads. This is a worse case scenario although fine sized material that is meant to pass through the filter will coagulate and congregate further downstream to create a potential clogging hazard. Strategic placement of the “Check filters” will avoid both of these problems.

From experience and extensive tests carried out with effluent water it is recommended to use a mesh grade lower for the check filter than the main automatic filter eg if the main filter has a 120 mesh rating, it is quite acceptable to use 80 mesh for the check filter. It may sound strange but this is the fact of the matter.

8.3 Manual or Automatic?

The trend is definitely toward automation. All end users will confirm the initial cost of an effective and efficient system is justified. Methods of automation include:

- ◆ Time interval
Based on solenoid and timer combination. The timer sensor is reliable provided water quality and flow rate remain constant
- ◆ Quantity interval
Similar to time
- ◆ Pressure differential
By means of a pressure differential sensor the filters can be flushed at a preset pressure difference. Usually 5 to 7m (8 to 11psi) is acceptable.
- ◆ Pressure and Time combination
Considered the best method especially in multi filter batteries. Netafim systems have time as primary measure with pressure differential as back up.

Let us consider the pros and cons of automatic versus manual filters

Table 4

Advantages	Disadvantages
System Pressure maintained downstream, meaning better water distribution and fewer blockages	Cost
Less task disruption	Requires operator understanding
The timer/sensor does not “forget”	More components
Operator has “peace of mind”	
Energy savings as filter is kept clean and head loss is reduced	

8.4 Pre-filtration

Sometimes it is necessary to pay special attention to treatment of the water, placement of the suction line and devices in line before the main filter itself. The depth at which the suction strainer is placed can determine whether the main filter is overloaded or not.. The location of the foot valve on a suction line can influence a filter’s ability to perform correctly. Factors to be considered include:

- ◆ Debris from rivers or channels: A well may have to be installed away from the channel to protect the filter from loading up with leaves, branches etc.,
- ◆ Wind direction: In large dams, prevailing winds may force algae and debris to build up at one end of the dam. The foot valve should always be located at the opposite end of the dam,

- ◆ Iron levels: Where high iron levels are present, the suction line should be floated close to the surface of a dam, as the iron content at this level will be much less than lower down in the dam,

Foot valves should always be fitted with a suction filter, to help prevent it from blocking up with contaminants. If the foot valve is allowed to block, pumps may lose prime and may be damaged if left to run dry. This may lead to damage in the pump impellers, housings, back flush valve, filters and check valves. For safety, pumps should be fitted with low flow, pressure and loss of prime sensors.

There are automatic suction strainers available (eg Odis 18100 series) See Figure 9 below

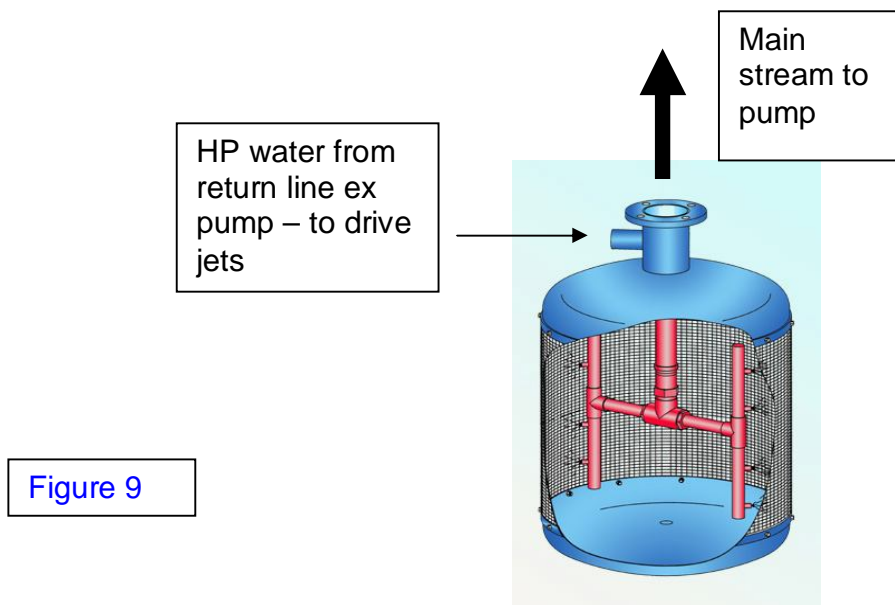

Figure 9

All the pumped water flows through the strainer and debris is stopped on the heavy duty stainless steel screen. The screen is kept clean by continuously rotating jets using pump pressure from a return line, which blows dirt off the screen from the inside.

In addition to the suction strainers a pre-filtration strainer can be fitted to prevent the passage of coarse solids, frogs and fish etc. The perforations on the screens will be from 3mm to 8mm. This affords extra protection to the pump and the system in general.

8.5 What mesh rating to select?

We can understand that drip irrigation requires a finer grade of filtration than impact sprinklers. And we imagine that micro sprinklers would be somewhere in between? A filter that is too coarse will result in frequent emitter blockages whilst one that is too fine will result in frequent filter blockages. Also the “clean” head loss in the latter example will mean a larger, unnecessarily expensive filter, all other things being equal.

As a general “Rule of Thumb” it is accepted that

- ◆ Drip Irrigation requires a particle size 1/6 to 1/10 of the emitters smallest opening
- ◆ Micro sprinklers, jets etc require a particle size 1/3 to 1/6 of the emitters smallest opening

It is always recommended to pay attention to the various manufacturers’ requirements. Generally all Netafim drip products require 120 mesh (130 μ) filtration. However it is advisable to

use 140 mesh (100 μ) with sub 1 litre/hr emitters manufactured by Netafim. Please refer to Table 5 below

Mesh Requirements for Different Emitter types and flows

Table 5

Emitter Type	Flow (L/hr)	Mesh #	Micron (μ)	Comment
Netafim Dripper	2 - 24	120	130	Button or "On-line" drippers
Netafim Dripline	1 - 4	120	130	Tapes and Heavy wall dripline
Netafim Dripline "Tiran"	8	80	200	Heavy dripline for Heap Leaching
Netafim Dripline	'1	140	100	New generation "Low flow"
Netafim Coolnet	7.5 - 16	120	130	Low pressure "fogger"
Netafim micro sprinklers	28 - 55	80 - 120	130 - 200	Includes Jets and sprays
Netafim micro sprinklers	55 - 120	80	200	Ditto
Netafim micro sprinklers	120 - 200	40 - 80	200 - 400	Ditto
Netafim midi sprinklers	160 - 300	40	400	Gyronet and Powernet family
Netafim Impact	\geq 300	40	400	Cyclone, Banet
Netafim Pop up	\geq 300	120	130	To protect Pop ups filter
Others Pop up	\geq 300	120	130	Ditto

9 Installation and Maintenance

9.1 Installation

Normally the main filtration system will be located alongside the pump station. If the operating head of the pump station exceeds the safe working range of the filters, this may not be possible. Where the full head is not needed, a pressure reducing valve must be fitted before the filter. If the full head is needed to push water some distance, the filter station may be installed further down the mainline, at a point where friction losses and or elevation will have reduced the pressure to within the filter's limits.

When designing a filter or pump station, the following should be considered:

- ◆ Installing a shed large enough to house the pumps, filters, fertigation and chemigation equipment,
- ◆ Mounting all equipment on a concrete slab floor,
- ◆ Providing sufficient lighting and ventilation,
- ◆ Providing a separate area for storage of chemicals.

To protect the filters, pumps and irrigation system, the following components may need to be installed:

- ◆ Isolation valves: on the inlet and outlet of the filtration manifold, so it can be isolated for servicing,
- ◆ Check valve: on the outlet manifold so water does not drain back into the pump and foot valve when the system is shut down, or if the foot valve fails,
- ◆ Pressure relief valve: should be installed where pump pressure exceeds safe working pressure of the filter or PVC mainline.,
- ◆ Fertiliser injection points: the inlet and outlet manifolds should be fitted with injection points, to allow injection at either location, depending on the type of fertiliser being injected,
- ◆ High pressure outlet: on the filter inlet, to provide a source of unfiltered water for filter maintenance,
- ◆ Lightning protection: a Line Surge Protector should be installed on the 240V AC mains to protect the flushing controller from surges induced by lightning.

9.2 Maintenance

For each filtration system, a maintenance program should be put into place. This should include both in-season and off-season tasks. The frequency of routine maintenance will depend on the type of filter system and the quality of the water source.

A General Maintenance program will look something like this

Daily

- ◆ Inspect system for leaks.

Weekly

- ◆ Check head loss across system: should be 7m or less,
- ◆ Check back flush controller operates correctly on manual cycle,

- ◆ Check automatic back wash operation,
- ◆ Check operation of back wash in response to the pressure differential (PD) switch.

End of Season

- ◆ Drain filter system,
- ◆ Open all filters and inspect media,
- ◆ Open and clean all backup filters: chemical clean discs if required,
- ◆ Check all "O"-rings for damage: replace if necessary,
- ◆ Grease all "O"-rings prior to installation,
- ◆ Pressurise system and check for leaks,
- ◆ Trigger back wash and check operation of all back wash valves,
- ◆ Check operation of pressure gauges,
- ◆ Check head loss across system under normal flow is less than 4m.

More detailed maintenance for specific filter types will be covered later.

10 Summary and Conclusion

We hope to have covered some basic ground material to prepare the reader for the more detailed Sections to follow on Screen, Gravel, Disc and Hydrocyclone filters. Filtration is considered the "Heart of the system" and many mistakes are made in practice with incorrect selection, design, operation and lack of attention to maintenance. Thankfully people are aware of the need for a good filtration system and the growers of today usually do not need to be convinced to purchase an automatic unit (as was the case 10 years ago) but need to be convinced of *what type of automatic filter* to invest in.

All filters are not equal, and once we have a better understanding of the water sources and quality that we are dealing with we are armed with the knowledge to make the correct choices.

11 Questions

These are divided into Beginners, Intermediate and Advanced levels

11.1 Beginner

- 1) Why is there a requirement for filtration?
- 2) What harm can sand cause in an irrigation system?
- 3) How many microns (μ) are there in 2mm?
- 4) What do we mean by "filter cake"?
- 5) Why would we use plastic rather than metal filters?
- 6) How much finer than "Very coarse sand" are "silt and clay" particles?
- 7) Name the 3 styles of filters commonly used in agriculture today.
- 8) What type of filters do most households with swimming pools use?
- 9) Describe *in your own words* a disc filter.
- 10) How much water does an automatic screen filter use to backwash compared to disc filters?
- 11) Describe how a hydro cyclone (sand separator) operates.
- 12) What is a "check filter"?
- 13) What is the "Rule of Thumb" for mesh rating selection for drippers and microsprinklers?
- 14) How big should the filter/pump shed be?
- 15) What should be daily maintenance for your filter system?

11.2 Intermediate

- 1) Explain what is meant by TSS and how does it affect our filtration selection?
- 2) What do you understand by the term "Delta P", and what is the acceptable range for a dirty filter?
- 3) What determines "flushing frequency"?
- 4) What materials are used in the construction of screen elements for screen filters?
- 5) What are the "best" and "worst" sources of water that irrigators use and what has to be taken into consideration with them with regards to filtration?
- 6) What level of Iron in water is considered to pose a "slight to moderate" risk of blockages for drippers?
- 7) What are the shapes of particles in irrigation water?
- 8) How much sand in water will necessitate removal by a hydro cyclone?
- 9) What do you understand by a "Depth or Volume" style of filter?
- 10) How does a disc filter automatically backwash? Describe the process.
- 11) What methods are used to clean automatic screen filters?
- 12) Apart from removing sand from water what else can hydro cyclones do for us?
- 13) With water that carries a light load of algae what would be our preferred choice of filter type and why?
- 14) What are the main methods of automation control for filters and what would be *your* first choice, and why?
- 15) Generally speaking what level of filtration do Netafim drippers require?
- 16) In your own words, why should we bother with maintenance?

11.3 Advanced

- 1) Why are we not really concerned with “turbidity” when considering agricultural filtration?
- 2) What are the repercussions of too high a “flow velocity” in the various filter types we use?
- 3) Explain *in your own words* what you understand by “channeling/tunneling” in gravel filters?
- 4) Why would we use SS316 as opposed to SS314 in an agricultural application?
- 5) Where do “single cell micro organisms” grow, what harm can they do us, and how do we deal with them?
- 6) Explain *in your own words* the types of changes that can occur to water sources over time?
- 7) Why does a high pH in water pose a greater blockage threat to our drip system, rather than a low pH?
- 8) How do we remove clay and silt from our irrigation water? What happens if we don't?
- 9) What do mean by “filtration is a statistical process”? Explain *in your own words*.
- 10) What happens if the back wash flow in a gravel filter is too low or too high? How do we measure it and how do we control it?
- 11) Where and why would we use an automatic screen filter?
- 12) How do maximise the efficiency of a hydro cyclone, and what special considerations should be taken into account?
- 13) How do you convince a grower that he should use a “check filter” in the paddock, after all it is an added cost?
- 14) List in order of Priority the main advantages of automatic versus manual filters, and why?
- 15) What special considerations do we need to make when locating our pump suction with regards to the main filter's performance?
- 16) What level of filtration should we use for Pop-up sprinklers and why?
- 17) How would you persuade the grower to take on board a regular and organised Maintenance program for his filters? What information would you give him and how would you present it?

Acknowledgements

This paper prepared by Wayne Ingram (Netafim School of Irrigation) Netafim Australia